

Square shoulder milling new generation



LINEPRO
20090 | 20190 | 20290

PHP
NEW
GRADE

PHS
NEW
GRADE

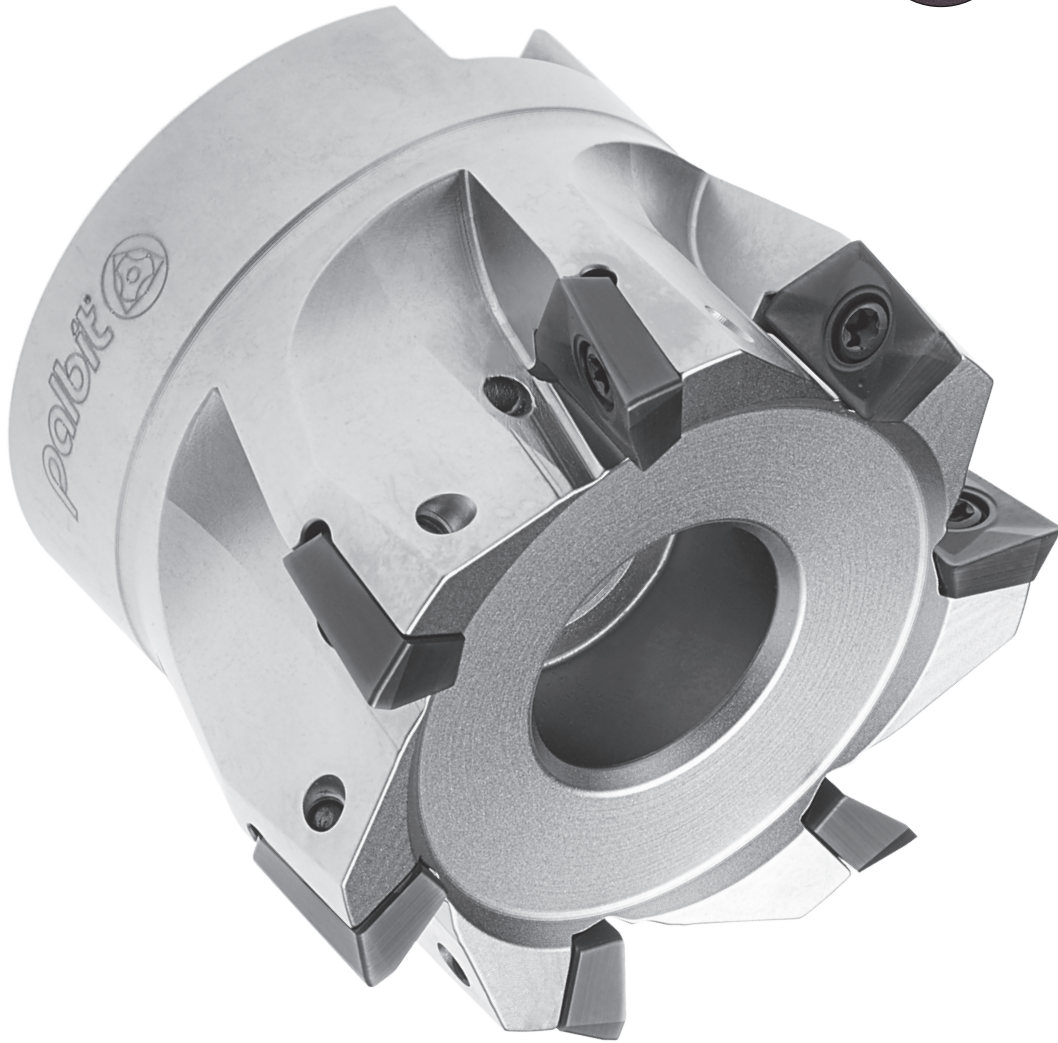

INSERT SIZE
06 XP...
0602...

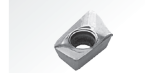

NEW

INSERT SIZE
10 XP...
1003...

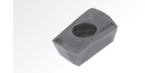

NEW

INSERT SIZE
17 XPET
1706...



NEW

SINCE 1916

LINEPRO 20090

P M K N S

INSERT SIZE
06 XP...
0602...

XPET-LP

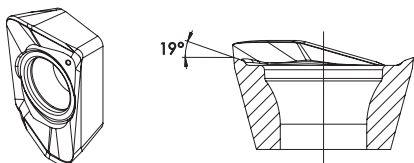

XPET-LN

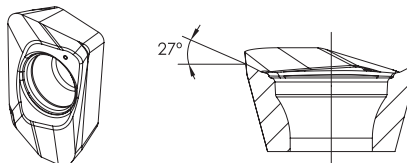

XPET-HF

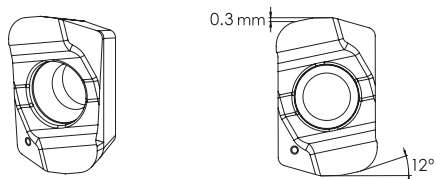

XPHW-MH

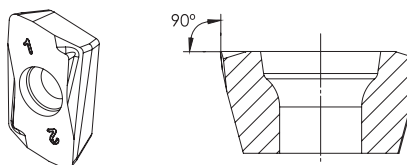

XPET-LP



XPET-HF



XPET-LN **NEW**



XPHW-MH **NEW**



LINEPRO 20190

INSERT SIZE
10 XP...
1003...

XPET-LP

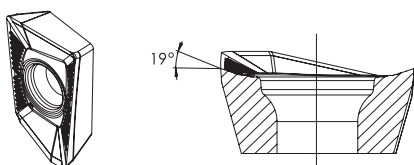

XPET-MP

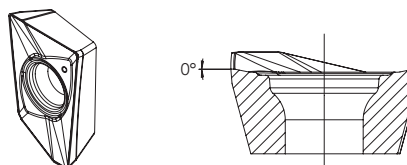

XPET-LN

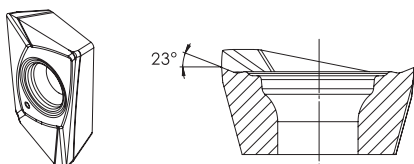

XPET-HF

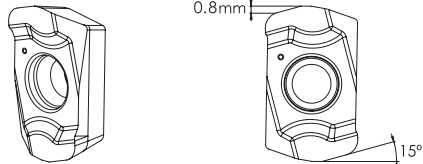

XPHW-MH

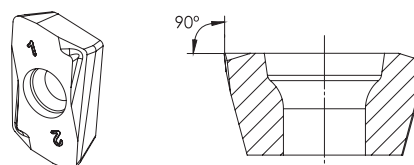

XPET-LP



XPET-MP



XPET-LN



XPET-HF



XPHW-MH **NEW**



LINEPRO 20290



INSERT SIZE
17 XPET
1706...

- XPET-LP
- XPET-MP
- XPET-LN

XPET-LP

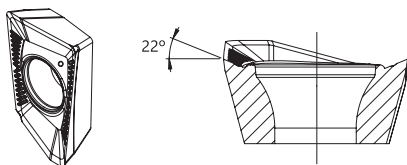

XPET-MP

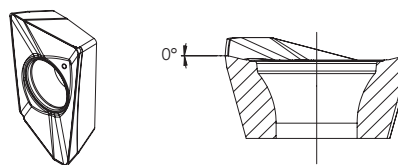

XPET-LN

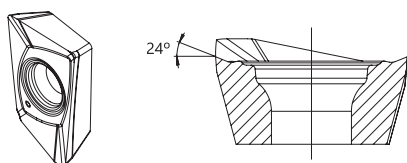

CHIP BREAKERS | Quebra- aparas | Rompevirutas

Chip Breaker	Features Características Características
Geometry HF Hifeed machining	New chipbreaker HF for Hifeed machining in all materials.
Geometry LP Light machining	Positive top rake angle to promote a good chip flow and reduce power consumption on low alloy steels.
Geometry MP Light machining	Chip-breaker with a reinforced chamfer for general applications on steel and cast iron.
Geometry LN Light machining	High positive chip-breaker, polished for applications of non ferrous materials (aluminum).
Geometry MH Light machining	First choice for Hard Materials in finishing operations.

INSERTS FEATURES

NEW

XPET-LN

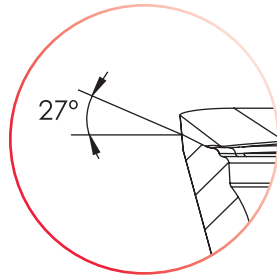
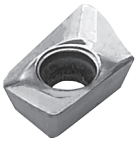

XPET-LN SPECIFICATIONS

- Positive rake angle to promote a smooth cut;
- Polished surface to avoid built-up edge;
- First choice for non-ferrous materials.

XPHW-MH

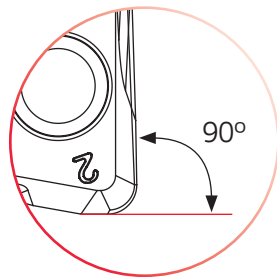
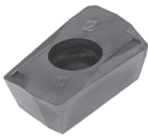

XPHW-MH SPECIFICATIONS

- Flat top insert for optimized finishing operations;
- Reinforced geometry to improve edge resistance;
- Perfect 90° cutting edge for excellent wall accuracy.

CUTTER FEATURES

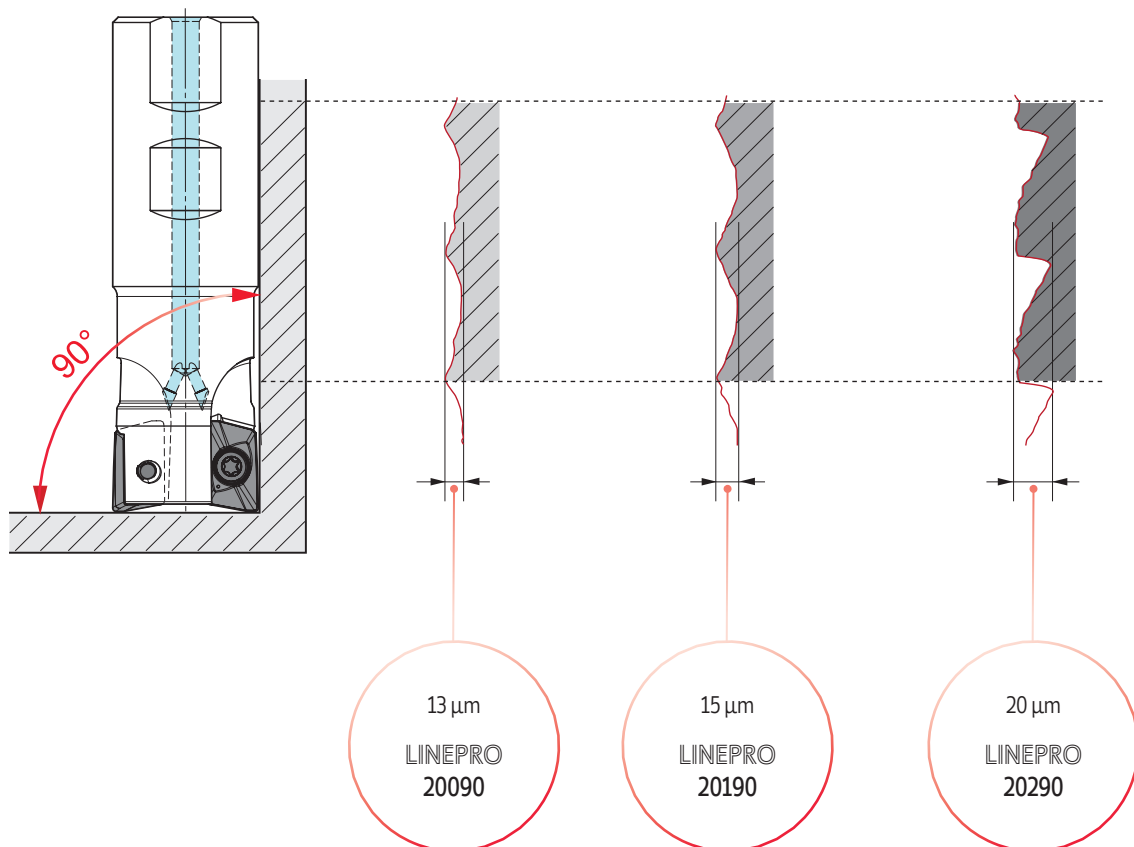

CUTTER FEATURES

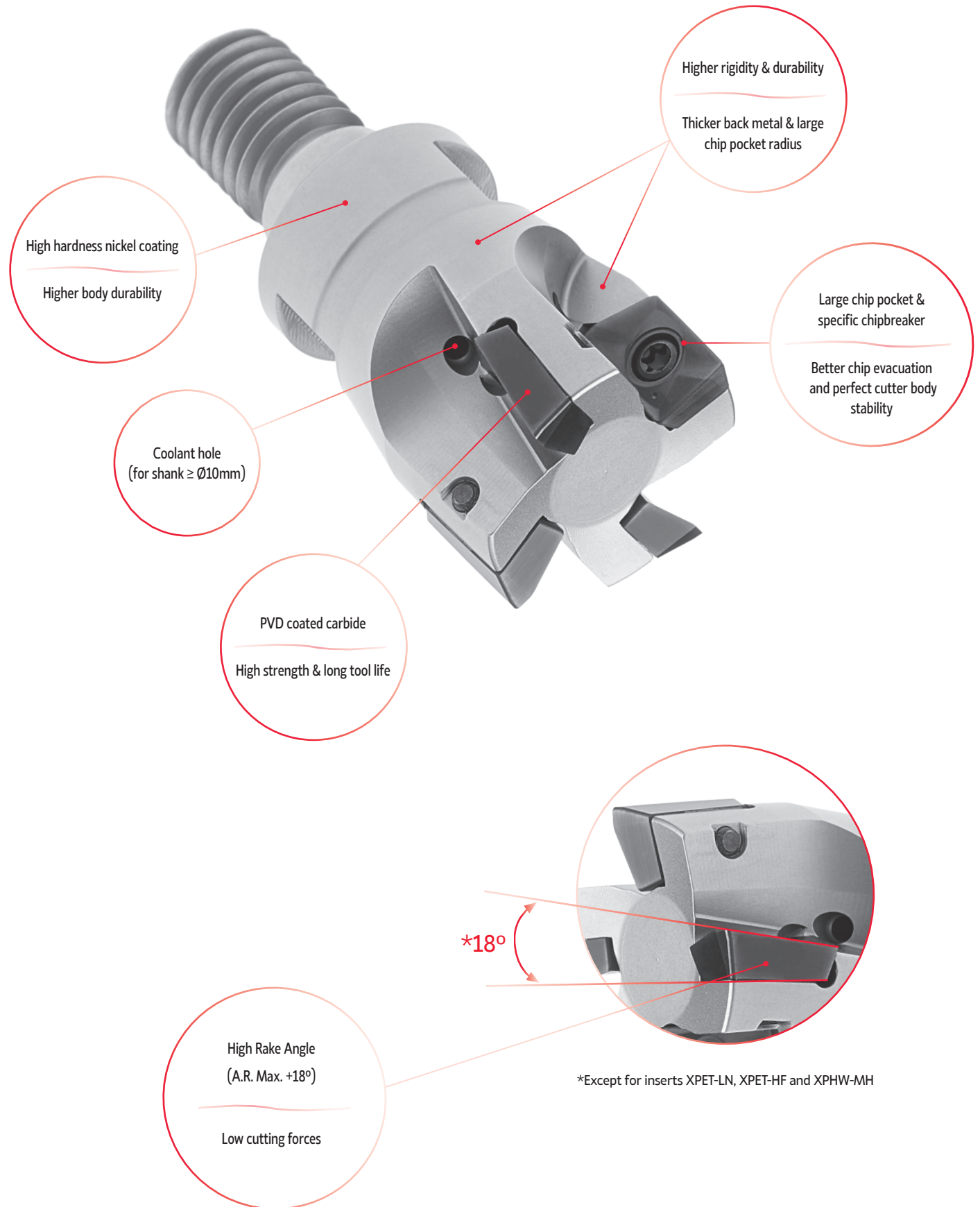

High hardness nickel coating
Higher body durability

Coolant hole
(for shank $\geq \text{Ø}10\text{mm}$)

PVD coated carbide
High strength & long tool life

Higher rigidity & durability

Thicker back metal & large
chip pocket radius

Large chip pocket &
specific chipbreaker

Better chip evacuation
and perfect cutter body
stability

High Rake Angle
(A.R. Max. $+18^\circ$)

Low cutting forces

$*18^\circ$

*Except for inserts XPET-LN, XPET-HF and XPHW-MH

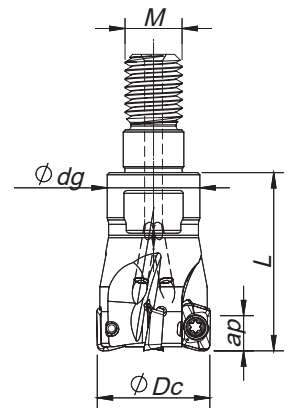

Threaded Coupling

$K_r=90^\circ$ | $\gamma_p=+4^\circ$

Order code Código	Reference Referência Referencia		Dimensions Dimensões Dimensiones (mm)				Kg	Max ap (mm)			Insert Pastilha Inserto	Stock
			ϕDc	ϕM	ϕdg	L		LP LN	HF	MH		
181120400	010R20090-02-04-M06020	2	10	M6	9,8	20	0,01	4,00	0,30	2,00	XP... 0602...	
181112800	011R20090-02-04-M06020	2	11	M6	9,8	20	0,01	4,00	0,30	2,00	XP... 0602...	
181120500	012R20090-03-04-M06020	3	12	M6	9,8	20	0,02	4,00	0,30	2,00	XP... 0602...	
181112900	013R20090-03-04-M06020	3	13	M6	9,8	20	0,02	4,00	0,30	2,00	XP... 0602...	
181087500	016R20090-04-04-M08025	4	16	M8	13,0	25	0,03	4,00	0,30	2,00	XP... 0602...	
181113000	017R20090-04-04-M08025	4	17	M8	13,0	25	0,04	4,00	0,30	2,00	XP... 0602...	
181087600	020R20090-05-04-M10030	5	20	M10	18,0	30	0,06	4,00	0,30	2,00	XP... 0602...	
181087700	025R20090-07-04-M12030	7	25	M12	21,0	30	0,09	4,00	0,30	2,00	XP... 0602...	
181087800	032R20090-08-04-M16035	8	32	M16	29,0	35	0,19	4,00	0,30	2,00	XP... 0602...	

Stock item | Produto de stock | Itens de stock

Available under request | Disponível sobre consulta | Disponible bajo consulta

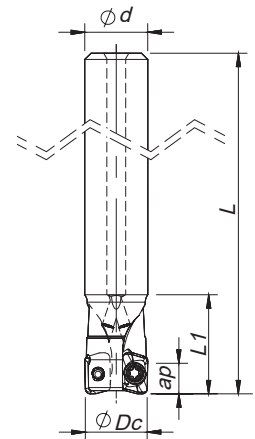

Cylindrical Shank

$K_r=90^\circ$ | $\gamma_p=+4^\circ$

Order code Código	Reference Referência Referencia		Dimensions Dimensões Dimensiones (mm)				Kg	Max ap (mm)			Insert Pastilha Inserto	Stock
			ϕDc	ϕd	L	L1		LP LN	HF	MH		
181087100	010E20090-02-04-010055	2	10	10	55	16	0,03	4,00	0,30	2,00	XP... 0602...	
181108300	010E20090-02-04-010100	2	10	10	100	25	0,03	4,00	0,30	2,00	XP... 0602...	
181087200	012E20090-02-04-012080	2	12	12	80	17	0,06	4,00	0,30	2,00	XP... 0602...	
181109900	012E20090-03-04-012120	3	12	12	120	30	0,06	4,00	0,30	2,00	XP... 0602...	
181087300	016E20090-03-04-016090	3	16	16	90	20	0,12	4,00	0,30	2,00	XP... 0602...	
181087400	016E20090-04-04-016090	4	16	16	90	20	0,11	4,00	0,30	2,00	XP... 0602...	
181097100	017E20090-05-04-016090	5	17	16	90	35	0,11	4,00	0,30	2,00	XP... 0602...	
181097200	021E20090-05-04-020090	5	21	20	90	35	0,13	4,00	0,30	2,00	XP... 0602...	

Stock item | Produto de stock | Itens de stock

Available under request | Disponível sobre consulta | Disponible bajo consulta



XP... 0602... || Inserts | Pastilhas | Plaquetas

XPET-LP

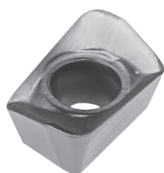

XPET-LN

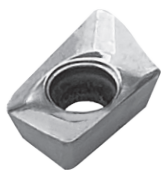

XPET-LP | LN

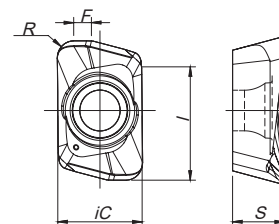

XPET-HF

XPET-HF
(HiFeed geometry)

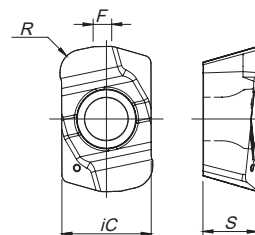
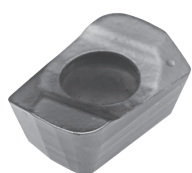

XPHW-MH

XPHW-MH
(finishing geometry)

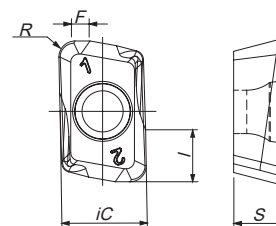
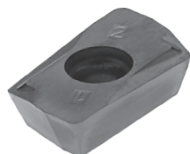

	(2) Grade code	P				M	K	N	S	H		Dimensions Dimensões Dimensiones (mm)					
		PVD				PVD	CVD	PVD	UNC	PVD	PVD						
		X4	X6	T1	P4	X9	T1	P4	10	X9	X4						X6
(1) Geometry code	ISO Reference	PHH603	PHH910	PHP920	PHP930	PHH930	PHP920	PHP930	PH0910	PHH930	PHH603	PHH910	iC	S	I	R	F
1112002	XPET 060204 PDER-LP			⊗	⊗	⊗	⊗	⊗		⊗			3,90	2,40	5,30	0,40	0,80
1112003	XPET 060208 PDER-LP			⊗	⊗	⊗	⊗	⊗		⊗			3,90	2,40	5,30	0,80	0,70
1112004	XPET 060216 PDER-LP			⊗	⊗		⊗	⊗					3,90	2,40	5,30	1,60	0,60
1112579	XPET 060202 PDFR-LN								⊗				3,90	2,40	5,10	0,20	0,95
1112580	XPET 060204 PDFR-LN								⊗				3,90	2,40	5,10	0,40	0,80
1112049	XPET 060210 ZER-HF			⊗	⊗	⊗	⊗	⊗		⊗			3,90	2,40	-	1,00	0,80
1112259	XPHW 060208 ZER-MH	⊗	⊗								⊗	⊗	3,90	2,40	2,40	0,80	0,70

⊗ First choice | Primeira opção | 1ª opción

⊗ Stock item | Produto de stock | Itens de stock

○ Available under request | Disponível sobre consulta | Disponible bajo consulta

Insert order code = (1) Geometry Code + (2) Grade Code

LINEPRO 20090

SPARE PARTS | Complementos | Repuestos

Cutter ØDc	Insert Screw	Key (Torx)	Order separately	
			Key (Torx - Nm)	Torque Value
E20090 - 10	P0180300	XT06IP	DT0606IP	0,6
E20090 - 12-16	P0180400	XT06IP	DT0606IP	0,6
R20090 - 12-16	P0180400	XT06IP	DT0606IP	0,6

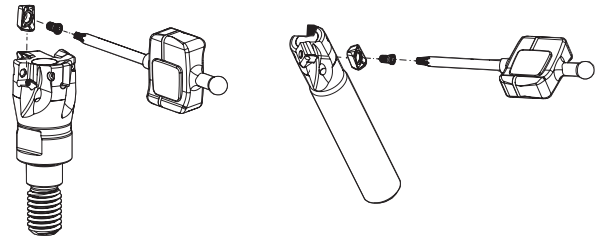

GRADES SELECTION GUIDE | Guia para selección de graus | Tabla para selección de calidades

ISO	PSM	Material	HB (Brinell)	Grades					
				← Wear Resistance			Toughness →		
				PH0910	PHH603	PHH910	PHP920	PHP930	PHH930
P	1	Unalloyed Steel	125-220	●	●	●	✓	✓	
	2	Low-Alloyed Steel	220-280			✓	✓	✓	
	3	High-Alloyed Steel	280-380		✓	✓	✓	✓	
M	4	SS - Ferritic / Martensitic	200-330						✓
	5	SS - Austenitic	200-330						✓
	6	SS - Austenitic-ferritic (Duplex)	230-260						✓
K	7	Malleable Cast Iron	130-230				✓	✓	
	8	Grey Cast Iron	180-245				✓	✓	
	9	Nodular Cast iron	160-250				✓	✓	
N	10	Aluminium and Non Ferrous	30-130	✓					
S	11	Heat Resistant Super Alloys	200-320						✓
H	12	Hardened Steels	40-55 HRC		✓	✓			

- Good Conditions
- Average Conditions
- Difficult Conditions

RECOMMENDED CUTTING CONDITIONS | Condições de corte recomendadas | Condiciones de corte recomendables

ISO	PSM	Material	HB (Brinell)	Vc (m/min)					
				← Wear Resistance				Toughness →	
				PH0910	PHH603	PHH910	PHP920	PHP930	PHH930
P	1	Unalloyed Steel	125-220	-	-	-	180-250	160-230	-
	2	Low-Alloyed Steel	220-280	-	-	160-270	160-230	140-210	-
	3	High-Alloyed Steel	280-380	-	180-310	140-230	140-220	120-200	-
M	4	SS - Ferritic / Martensitic	200-330	-	-	-	-	-	140-210
	5	SS - Austenitic	200-330	-	-	-	-	-	120-170
	6	SS - Austenitic-ferritic (Duplex)	230-260	-	-	-	-	-	100-150
K	7	Malleable Cast Iron	130-230	-	-	-	160-270	150-250	-
	8	Grey Cast Iron	180-245	-	-	-	140-250	140-230	-
	9	Nodular Cast iron	160-250	-	-	-	120-210	100-200	-
N	10	Aluminium and Non Ferrous	30-130	100-2000	-	-	-	-	-
S	11	Heat Resistant Super Alloys	200-320	-	-	-	-	-	30-110
H	12	Hardened Steels	40-55 HRC	-	70-270	70-260	-	-	-

ISO	PSM	Material	HB (Brinell)	Feed fz (mm/t)			
				XPET 06...LP	XPET 06...LN	XPET 06...HF	XPHW 06...MH
P	1	Unalloyed Steel	125-220	0,05-0,07	-	0,40-0,80	-
	2	Low-Alloyed Steel	220-280	0,05-0,07	-	0,40-0,80	0,05-0,12
	3	High-Alloyed Steel	280-380	0,05-0,07	-	0,40-0,60	0,05-0,12
M	4	SS - Ferritic / Martensitic	200-330	0,05-0,07	-	0,40-0,80	-
	5	SS - Austenitic	200-330	0,05-0,07	-	0,40-0,60	-
	6	SS - Austenitic-ferritic (Duplex)	230-260	0,05-0,07	-	0,40-0,60	-
K	7	Malleable Cast Iron	130-230	0,05-0,07	-	0,40-0,80	-
	8	Grey Cast Iron	180-245	0,05-0,07	-	0,40-0,80	-
	9	Nodular Cast iron	160-250	0,05-0,07	-	0,40-0,80	-
N	10	Aluminium and Non Ferrous	30-130	-	0,05-0,07	-	-
S	11	Heat Resistant Super Alloys	200-320	0,05-0,07	-	0,40-0,60	-
H	12	Hardened Steels	40-55 HRC	-	-	-	0,03-0,10

(Note 1) Cutting conditions $a_e/D_c=70\%$.

(Note 2) It's possible to occur vibrations in certain cases. Please reduce depth of cut and / or reduce cutting conditions in following cases:

- When using long shank;
- When using long tool overhang with arbor type;
- When application has poor clamping rigidity or when using a low rigidity machine.

(Note 3) PH5... and PH5... can be used wet or dry. PH7... use only air.

(Note 4) It's possible to occur vibrations in certain cases. Please reduce depth of cut and / or reduce cutting conditions in following cases:

- When using long shank;
- When using long tool overhang with arbor type;
- When application has poor clamping rigidity or when using a low rigidity machine.

Operation	a_e	Vc & fz	a_p (mm)
Slotting	100%	<20%	1,0-3,0
Shouldering	<50%	>8%	1,0-4,0
	≤25%	>12%	1,0-4,0

LINEPRO 20090

CHIP-BREAKER SELECTION GUIDE | Guia para aplicações do quebra- aparas | Guía para aplicación del rompevirutas

ISO	PSM	Material	HB (Brinell)	Chip-Breaker Application	
				1st choice	Difficult Operations
P	1	Unalloyed Steel	125-220	XPET 06... LP/HF	-
	2	Low-Alloyed Steel	220-280	XPET 06... LP/HF	XPHW 06... MH
	3	High-Alloyed Steel	280-380	XPET 06... LP/HF	XPHW 06... MH
M	4	SS - Ferritic / Martensitic	200-330	XPET 06... LP/HF	-
	5	SS - Austenitic	200-330	XPET 06... LP/HF	-
	6	SS - Austenitic-ferritic (Duplex)	230-260	XPET 06... LP/HF	-
K	7	Malleable Cast Iron	130-230	XPET 06... LP/HF	-
	8	Grey Cast Iron	180-245	XPET 06... LP/HF	-
	9	Nodular Cast iron	160-250	XPET 06... LP/HF	-
N	10	Aluminium and Non Ferrous	30-130	XPET 06... LN	-
S	11	Heat Resistant Super Alloys	200-320	XPET 06... LP/HF	-
H	12	Hardened Steels	40-55 HRC	XPHW 06... MH	-

PROGRAMMING DATA | Dados para programação | Datos para la programación

Insert	Programming Data		
	Rp	X	b
XPET 06 HF	1,1	0,84	2,3

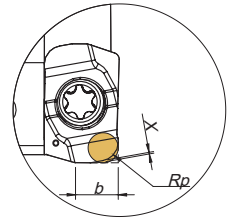

RAMPING AND HELICAL INTERPOLATION

Descida em rampa e interpolação helicoidal | Bajada en rampa e interpolación circular

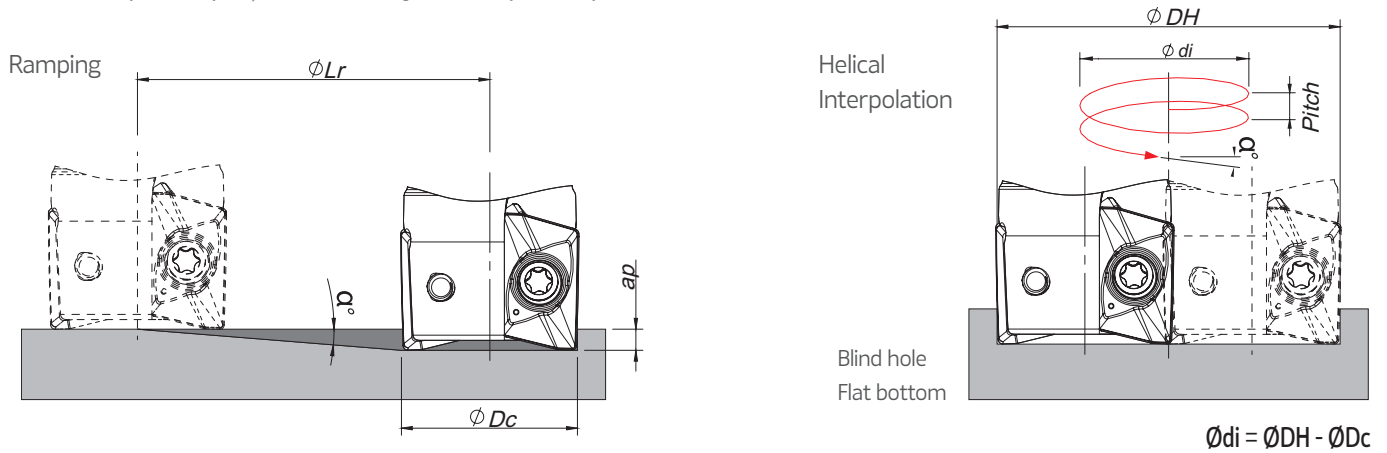

ϕD_c	Ramping			Helical Interpolation		
				Diameter for Blind Hole, Flat Bottom Face (1)		Max Pitch/Rev.
	Max Ramp a°	Max a_p	Min Lr	ϕDH_{min}	ϕDH_{max}	
10	5,5	4,0	41,5	17,2 -	- 18,4	2,2 2,5
12	4,0	4,0	57,2	21,2 -	- 22,4	2,0 2,3
16	2,5	4,0	91,6	29,2 -	- 30,4	1,8 2,0
17	2,2	4,0	104,1	31,2 -	- 32,4	1,7 1,9
20	1,9	4,0	120,6	37,2 -	- 38,4	1,8 1,9
21	1,6	4,0	143,2	39,2 -	- 40,4	1,6 1,7
25	1,3	4,0	171,0	47,2 -	- 48,4	1,6 1,7
32	1,0	4,0	229,2	61,2 -	- 62,4	1,6 1,7

(1) using LP insert with radius 0,8 mm

Note: During helical interpolation do not exceed maximum pitch

When using HF insert or other different insert radius to calculate the ϕDH_{min} and ϕDH_{max} use the equation below:

- Minimum Diameter: $\phi DH_{min} = 2 \times (\phi D_c - (R \text{ corner radius} + F \text{ width of edge wiper}))$

- Maximum Diameter: $\phi DH_{max} = 2 \times (\phi D_c - R \text{ corner radius})$

(On HF insert the corner radius should be corner radius programming)

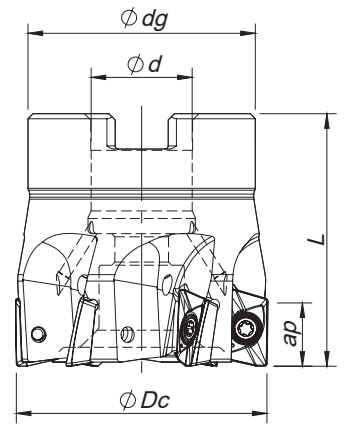
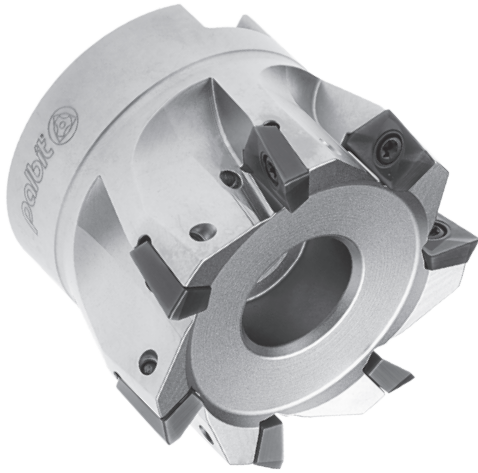

Arbor Mounting

$K_r=90^\circ$ | $\gamma_p=+8^\circ$

Order code Código	Reference Referência Referencia		Dimensions Dimensões Dimensiones (mm)				Kg	Max ap (mm)			Arbor Style	Insert Pastilha Inserto	Stock
			ϕDc	ϕd	ϕdg	L		LP/MP	HF	MH			
181088600	040A20190-06-08-016040	6	40	16	36	40	0,22	10,0	0,80	3,00	A	XP... 1003...	
181088700	050A20190-07-08-022040	7	50	22	42	40	0,31	10,0	0,80	3,00	A	XP... 1003...	
181088800	063A20190-08-08-022040	8	63	22	52	40	0,43	10,0	0,80	3,00	A	XP... 1003...	

Stock item | Produto de stock | Itens de stock

Available under request | Disponível sobre consulta | Disponible bajo consulta

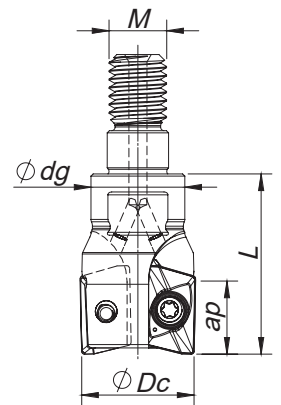

Threaded Coupling

$K_r=90^\circ$ | $\gamma_p=+5^\circ \sim +6^\circ$

Order code Código	Reference Referência Referencia		Dimensions Dimensões Dimensiones (mm)				Kg	Max ap (mm)			Insert Pastilha Inserto	Stock
			ϕDc	ϕM	ϕdg	L		LP/MP	HF	MH		
181088200	016R20190-02-05-M08025	2	16	M8	14	25	0,03	10,0	0,80	3,00	XP... 1003...	
181088300	020R20190-03-05-M10030	3	20	M10	18	30	0,06	10,0	0,80	3,00	XP... 1003...	
181088400	025R20190-04-05-M12035	4	25	M12	21	35	0,12	10,0	0,80	3,00	XP... 1003...	
181088500	032R20190-05-06-M16035	5	32	M16	29	35	0,15	10,0	0,80	3,00	XP... 1003...	
181149100	040R20190-06-08-M16043	6	40	M16	29	43	0,25	10,0	0,80	3,00	XP... 1003...	

Stock item | Produto de stock | Itens de stock

Available under request | Disponível sobre consulta | Disponible bajo consulta

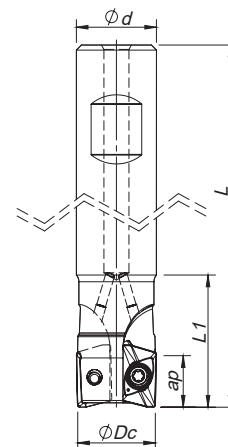

Weldon Shank

$K_r=90^\circ$ | $\gamma_p=+5^\circ\sim 8^\circ$

Order code Código	Reference Referência Referencia		Dimensions Dimensões Dimensiones (mm)				Kg	Max ap (mm)			Insert Pastilha Inserto	Stock
			ØDc	Ød	L	L1		LP/MP	HF	MH		
181087900	016W20190-02-05-016085	2	16	16	85	32	0,10	10,0	0,80	3,00	XP... 1003...	
181100600	016W20190-02-05-016150	2	16	16	150	70	0,13	10,0	0,80	3,00	XP... 1003...	
181108600	017W20190-02-05-016150	2	17	16	150	36	0,14	10,0	0,80	3,00	XP... 1003...	
181088000	020W20190-03-05-020090	3	20	20	90	28	0,21	10,0	0,80	3,00	XP... 1003...	
181100700	020W20190-03-05-020150	3	20	20	150	70	0,26	10,0	0,80	3,00	XP... 1003...	
181108700	022W20190-03-05-020150	3	22	20	150	70	0,30	10,0	0,80	3,00	XP... 1003...	
181088100	025W20190-04-05-025095	4	25	25	95	30	0,33	10,0	0,80	3,00	XP... 1003...	
181100800	025W20190-04-05-025150	4	25	25	150	80	0,36	10,0	0,80	3,00	XP... 1003...	
181108800	027W20190-04-05-025150	4	27	25	150	80	0,38	10,0	0,80	3,00	XP... 1003...	
181085400	032W20190-04-08-032110	4	32	32	110	50	0,55	10,0	0,80	3,00	XP... 1003...	

Stock item | Produto de stock | Itens de stock

Available under request | Disponível sobre consulta | Disponible bajo consulta

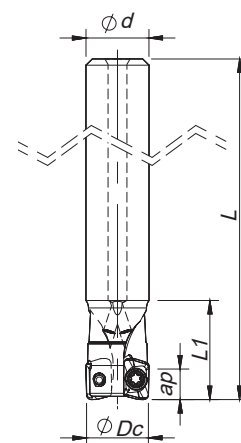

Cylindrical Shank

$K_r=90^\circ$ | $\gamma_p=+4^\circ$

Order code Código	Reference Referência Referencia		Dimensions Dimensões Dimensiones (mm)				Kg	Max ap (mm)			Insert Pastilha Inserto	Stock
			ØDc	Ød	L	L1		LP/MP	HF	MH		
181171700	016E20190-02-05-016085	2	16	16	85	32	0,10	10,0	0,8	3,0	XP...1003...	
181173000	016E20190-02-05-016150	2	16	16	150	70	0,13	10,0	0,8	3,0	XP...1003...	
181171600	020E20190-03-05-020090	3	20	20	90	28	0,21	10,0	0,8	3,0	XP...1003...	
181171800	020E20190-03-05-020150	3	20	20	150	70	0,26	10,0	0,8	3,0	XP...1003...	
181171400	025E20190-04-05-025095	4	25	25	95	30	0,33	10,0	0,8	3,0	XP...1003...	
181172900	025E20190-04-05-025150	4	25	25	150	80	0,36	10,0	0,8	3,0	XP...1003...	

Stock item | Produto de stock | Itens de stock

Available under request | Disponível sobre consulta | Disponible bajo consulta

LINEPRO 20190

XP... 1003... | Inserts | Pastilhas | Plaquetas

XPET-LP
(PHH-PHP grade)

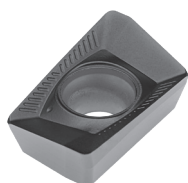

XPET-MP
(PHH-PHP grade)

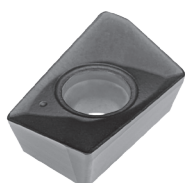

XPET-LN

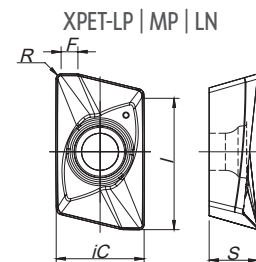

XPET-HF
(HiFeed geometry)



XPHW-MH
(finishing geometry)

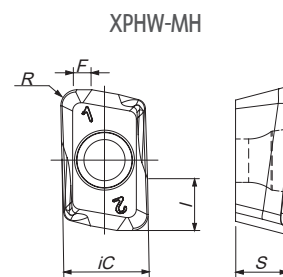
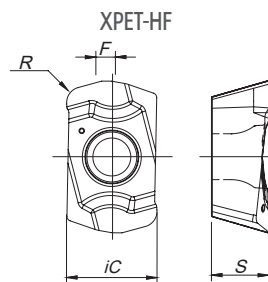
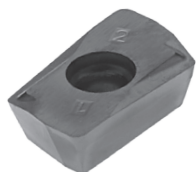

XPHW-R Z1

NEW

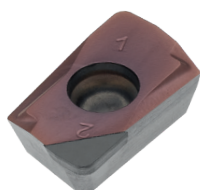

XPHW-R Z1

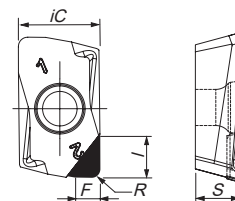

	(1) Geometry code	(2) Grade code	P		M	K			N	S	H		Dimensions Dimensões Dimensiones (mm)										
			CVD	PVD			PVD	CVD	PVD		UNC	PCD	PVD	PVD	iC	S	I	R	F				
			T9	G1	X5	T1	P4	X9	L5	L9	X5	T1	P4	10						D6	X9	X4	X6
NEW	1113132	XPET 100302 PDER-LP																	6,95	3,96	10,50	0,20	1,50
	1111980	XPET 100304 PDER-LP																	6,95	3,96	10,50	0,40	1,30
	1111981	XPET 100308 PDER-LP																	6,95	3,96	10,50	0,80	1,40
	1112022	XPET 100316 PDER-LP																	6,95	3,96	10,50	1,60	0,80
	1111982	XPET 100304 PDSR-MP																	6,95	3,96	10,50	0,40	1,10
	1111983	XPET 100308 PDSR-MP																	6,95	3,96	10,50	0,80	1,35
	1111984	XPET 100304 PDFR-LN																	6,95	3,96	10,50	0,40	0,75
	1112906	XPET 100308 PDFR-LN																	6,95	3,96	10,50	0,80	1,05
	1111985	XPET 100312 PDFR-LN																	6,95	3,96	10,50	1,20	0,75
	1112376	XPET 100312 ZDR-HF																	6,95	3,96	-	1,20	1,50
	1112500	XPHW 100308 ZER-MH																	6,95	3,60	3,00	0,80	1,30
	1112736	XPHW 100310 ZER-MH																	6,95	3,60	3,00	1,00	0,35
	1112735	XPHW 100320 ZER-MH																	6,95	3,60	3,00	1,20	1,10
	1112556	XPHW 100308 R Z1																	6,95	3,60	3,80	0,80	2,30

🟡 First choice | Primeira opção | 1ª opción

🟢 Stock item | Produto de stock | Itens de stock

⚪ Available under request | Disponível sobre consulta | Disponible bajo consulta

Insert order code = (1) Geometry Code + (2) Grade Code

SPARE PARTS | Complementos | Repuestos

Cutter ØDc	Insert Screw	Key (Torx)	Order separately	
			Key (Torx - Nm)	Torque Value
A20190 - 40-63	P0250704	XT08	DT0812	1,2
R20190 - 16	P0250503	XT08	DT0812	1,2
R20190 - 20-40	P0250704	XT08	DT0812	1,2
W20190 - 16-17	P0250503	XT08	DT0812	1,2
W20190 - 20-32	P0250704	XT08	DT0812	1,2
E20190 - 16	P0250503	XT08	DT0812	1,2
E20190 - 20-25	P0250704	XT08	DT0812	1,2

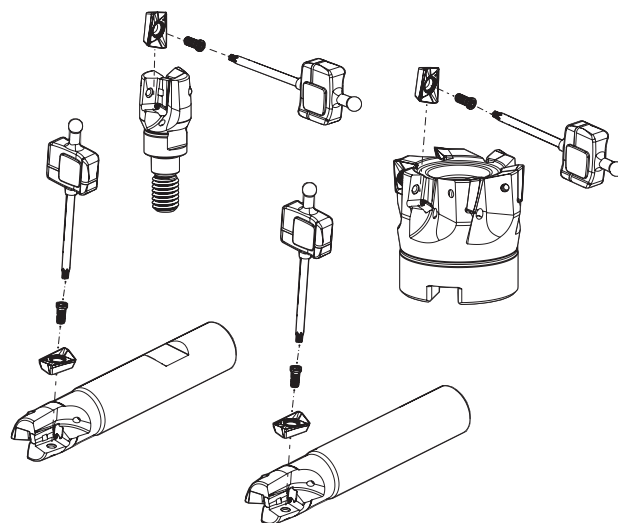

PROGRAMMING DATA | Dados para programação | Datos para la programación

Insert	Programming Data		
	Rp	X	b
XPET 10 HF	1,6	0,33	3,45

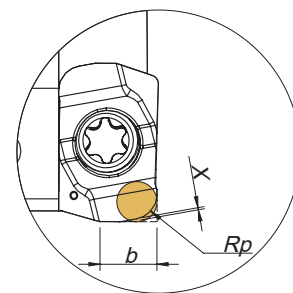

RAMPING AND HELICAL INTERPOLATION

Descida em rampa e interpolação helicoidal | Bajada en rampa e interpolación circular

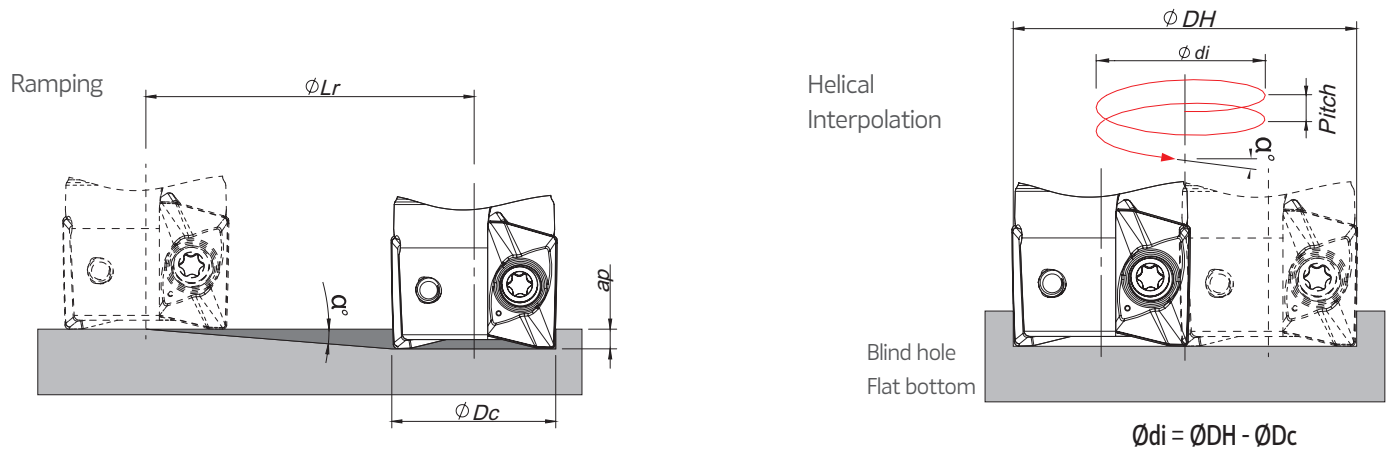

ϕD_c	Ramping			Helical Interpolation		
				Diameter for Blind Hole, Flat Bottom Face (1)		Max Pitch/Rev.
	Max Ramp a°	Max a_p	Min L_r	ϕDH_{min}	ϕDH_{max}	
16	7,5	10,0	76,0	27,6 -	- 30,4	4,8 6,0
17	7,0	10,0	81,4	29,6 -	- 32,4	4,9 5,9
20	5,0	10,0	114,3	35,6 -	- 38,4	4,3 5,1
22	4,5	10,0	127,1	39,6 -	- 42,4	4,3 5,0
25	3,5	10,0	163,5	45,6 -	- 48,4	4,0 4,5
27	3,0	10,0	190,8	49,6 -	- 52,4	3,7 4,2
32	2,5	10,0	229,0	59,6 -	- 62,4	3,8 4,2
40	1,7	10,0	336,9	75,6 -	- 78,4	3,3 3,6
50	1,3	10,0	440,7	95,6 -	- 98,4	3,2 3,4
63	1,0	10,0	572,9	121,6 -	- 124,4	3,2 3,4

(1) using LP insert with radius 0,8 mm

Note: During helical interpolation do not exceed maximum pitch

When using HF insert or other different insert radius to calculate the ϕDH_{min} and ϕDH_{max} use the equation below:

- Minimum Diameter: $\phi DH_{min} = 2 \times (\phi D_c - (R \text{ corner radius} + F \text{ width of edge wiper}))$

- Maximum Diameter: $\phi DH_{max} = 2 \times (\phi D_c - R \text{ corner radius})$

CHIP-BREAKER SELECTION GUIDE | Guia para aplicações do quebra- aparas | Guía para aplicación del rompevirutas

ISO	PSM	Material	HB (Brinell)	Chip-Breaker Application	
				1st choice	Difficult Operations
P	1	Unalloyed Steel	125-220	XPET 10 ... LP/HF	XPET 10 ... MP
	2	Low-Alloyed Steel	220-280	XPET 10 ... LP/HF	XPET 10 ... MP
	3	High-Alloyed Steel	280-380	XPET 10 ... MP/HF	-
M	4	SS - Ferritic / Martensitic	200-330	XPET 10 ... LP/HF	-
	5	SS - Austenitic	200-330	XPET 10 ... LP/HF	-
	6	SS - Austenitic-ferritic (Duplex)	230-260	XPET 10 ... LP/HF	-
K	7	Malleable Cast Iron	130-230	XPET 10 ... LP/HF	XPET 10 ... MP
	8	Grey Cast Iron	180-245	XPET 10 ... MP/HF	-
	9	Nodular Cast iron	160-250	XPET 10 ... MP/HF	-
N	10	Aluminium and Non Ferrous	30-130	XPET 10 ... LN/R Z1	-
S	11	Heat Resistant Super Alloys	200-320	XPET 10 ... LP/HF	-
H	12	Hardened Steels	40-55 HRC	XPHW 10 ... MH	-

GRADES SELECTION GUIDE | Guia para selecção de graus | Tabla para selección de calidades

ISO	PSM	Material	HB (Brinell)	Grades							PCD	
				← Wear Resistance				Toughness →				
				PH0910	PH5705	PHH603	PHP910	PHP920	PHP930	PHH930		PH5740
P	1	Unalloyed Steel	125-220	●	●	●	●	●	●	●	●	
	2	Low-Alloyed Steel	220-280				●	●	●		●	
	3	High-Alloyed Steel	280-380			●	●	●		●		
M	4	SS - Ferritic / Martensitic	200-330							●		
	5	SS - Austenitic	200-330							●		
	6	SS - Austenitic-ferritic (Duplex)	230-260							●		
K	7	Malleable Cast Iron	130-230		●		●	●	●		●	
	8	Grey Cast Iron	180-245		●		●	●	●		●	
	9	Nodular Cast iron	160-250		●		●	●	●		●	
N	10	Aluminium and Non Ferrous	30-130	●								●
S	11	Heat Resistant Super Alloys	200-320							●		
H	12	Hardened Steels	40-55 HRC			●						

● Good Conditions

● Average Conditions

● Difficult Conditions

RECOMMENDED CUTTING CONDITIONS | Condições de corte recomendadas | Condiciones de corte recomendables

ISO	PSM	Material	HB (Brinell)	Vc (m/min)									PCD
				← Wear Resistance						Toughness →			
				PH0910	PH5705	PHH603	PHP910	PHP920	PHP930	PHH930	PH5740	PHS740	
P	1	Unalloyed Steel	125-220	-	-	-	180-250	180-250	160-230	-	-	140-220	-
	2	Low-Alloyed Steel	220-280	-	-	-	160-240	160-230	140-210	-	-	120-200	-
	3	High-Alloyed Steel	280-380	-	-	180-310	140-230	140-220	120-200	-	-	100-190	-
M	4	SS - Ferritic / Martensitic	200-330	-	-	-	-	-	-	140-210	-	-	-
	5	SS - Austenitic	200-330	-	-	-	-	-	-	120-170	-	-	-
	6	SS - Austenitic-ferritic (Duplex)	230-260	-	-	-	-	-	-	100-150	-	-	-
K	7	Malleable Cast Iron	130-230	-	160-290	-	180-300	160-270	150-250	-	160-260	-	-
	8	Grey Cast Iron	180-245	-	170-320	-	160-250	140-250	140-230	-	140-240	-	-
	9	Nodular Cast iron	160-250	-	140-200	-	150-210	120-210	100-200	-	120-200	-	-
N	10	Aluminium and Non Ferrous	30-130	100-2000	-	-	-	-	-	-	-	-	100-3000
S	11	Heat Resistant Super Alloys	200-320	-	-	-	-	-	-	30-110	-	-	-
H	12	Hardened Steels	40-55 HRC	-	-	70-270	-	-	-	-	-	-	-

(Note 1): Cutting conditions $a_e/D_c=70\%$.

(Note 2): PH5... and PHS... can be used wet or dry. PH7... use only air.

(Note 3):

Operation	a_e	Vc & fz	a_p (mm)
Slotting	100%	<20%	2,0-4,0
Shouldering	<50%	>8%	3,0-6,0
	≤25%	>12%	7,0-9,0

(Note 4):

It's possible to occur vibrations in certain cases. Please reduce depth of cut and / or reduce cutting conditions in following cases:

- When using long shank;
- When using long tool overhang with arbor type;
- When application has poor clamping rigidity or when using a low rigidity machine.

Feed fz (mm/t)				
XPET 10... LP	XPET 10... MP	XPET 10... LN/R Z1	XPET 10... HF	XPHW 10... MH
0,08-0,20	0,10-0,25	-	0,40-0,80	0,10-0,25
0,08-0,20	0,10-0,20	-	0,40-0,80	0,10-0,25
0,08-0,15	0,10-0,20	-	0,40-0,60	0,10-0,25
0,08-0,20	0,10-0,20	-	0,40-0,70	-
0,08-0,20	0,10-0,20	-	0,40-0,70	-
0,08-0,15	0,10-0,20	-	0,40-0,60	-
0,08-0,20	0,10-0,25	-	0,50-0,80	-
0,08-0,20	0,10-0,25	-	0,50-0,80	-
0,08-0,20	0,10-0,20	-	0,50-0,60	-
-	-	0,07-0,25	-	-
0,05-0,07	-	-	0,40-0,60	-
-	-	-	-	0,08-0,15

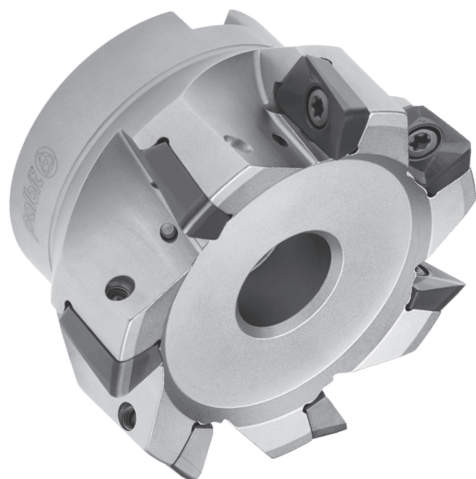

Arbor Mounting
 $K_r=90^\circ$ | $\gamma_p=+7^\circ \sim +8^\circ$

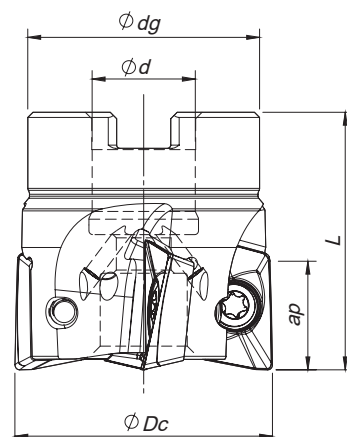

Order code Código	Reference Referência Referencia		Dimensions Dimensões Dimensiones (mm)				Kg	Specifications		Insert Pastilha Inserto	Stock
			ϕDc	ϕd	ϕdg	L		Arbor Type	Ap max (mm)		
181090900	040A20290-04-07-016040	4	40	16	32	40	0,18	A	17,0	XPET 1706...	
181091000	050A20290-05-08-022040	5	50	22	42	40	0,29	A	17,0	XPET 1706...	
181091100	063A20290-06-08-027040*	6	63	27	52	40	0,53	A	17,0	XPET 1706...	
181091200	080A20290-07-08-027050	7	80	27	60	50	0,92	A	17,0	XPET 1706...	
181091300	100A20290-08-08-032050	8	100	32	80	50	1,68	A	17,0	XPET 1706...	
181091400	125A20290-09-08-040063	9	125	40	90	63	3,01	A	17,0	XPET 1706...	

Stock item | Produto de stock | Itens de stock

Available under request | Disponível sobre consulta | Disponible bajo consulta

* For shank assembly a DIN 6920 screw is needed.



Weldon Shank
 $K_r=90^\circ$ | $\gamma_p=+6^\circ \sim +7^\circ$

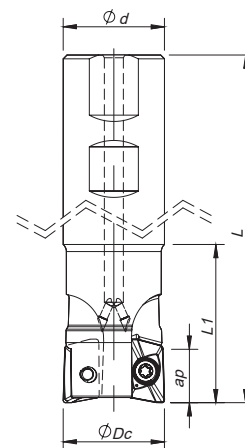

Order code Código	Reference Referência Referencia		Dimensions Dimensões Dimensiones (mm)				Kg	Specifications		Insert Pastilha Inserto	Stock
			ϕDc	ϕd	L	L1		Ap max (mm)			
181090500	032W20290-02-06-032110	2	32	32	110	50	0,56	17,0	XPET 1706...		
181090600	032W20290-02-06-032200	2	32	32	200	60	1,10	17,0	XPET 1706...		
181090700	040W20290-03-07-032115	3	40	32	115	50	0,67	17,0	XPET 1706...		
181090800	040W20290-03-07-032200	3	40	32	200	60	1,19	17,0	XPET 1706...		

Stock item | Produto de stock | Itens de stock

Available under request | Disponível sobre consulta | Disponible bajo consulta

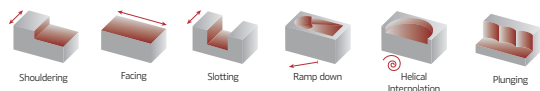

XPET 1706... | Inserts | Pastilhas | Plaquetas

XPET-LP

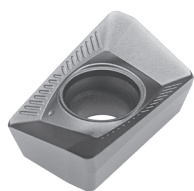

XPET-MP



XPET-LN



XPET-LP | MP | LN | LS

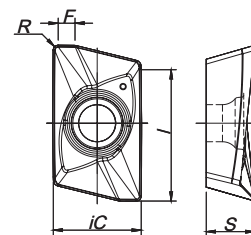

XPET-LS (PHH grade) **NEW**

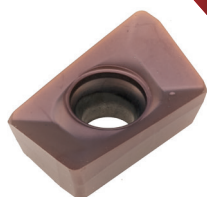

(1) Geometry code	(2) Grade code ISO Reference	P			M		K				N	S			Dimensions Dimensões Dimensiones (mm)				
		CVD	PVD		PVD		CVD		PVD		UNC	PVD			iC	S	I	R	F
		T9	T1	G6	X9	G6	L5	L9	T1	G6	10	X9	G6						
1111986	XPET 170608 PDER-LP		⊗	⊗		⊗			⊗	⊗			⊗	11,30	6,35	17,50	0,80	1,80	
1111987	XPET 170616 PDER-LP		⊗	⊗		⊗			⊗	⊗			⊗	11,30	6,35	17,50	1,60	1,20	
1111988	XPET 170608 PDSR-MP	⊗	⊗	⊗			⊗	⊗	⊗	⊗				11,30	6,35	17,50	0,80	1,80	
1111989	XPET 170616 PDSR-MP		⊗	⊗			⊗	⊗	⊗	⊗				11,30	6,35	17,50	1,60	1,00	
1111990	XPET 170608 PDFR-LN										⊗			11,30	6,35	17,50	0,80	1,20	
1111991	XPET 170620 PDFR-LN										⊗			11,30	6,35	17,50	2,00	1,00	
1111992	XPET 170632 PDFR-LN										⊗			11,30	6,35	17,50	3,20	0,80	
NEW 1112223	XPET 170608 PDER-LS				⊗	⊗						⊗	⊗	11,3	6,35	17,5	0,8	1,8	

⊗ First choice | Primeira opção | 1ª opción ⊗ Stock item | Produto de stock | Itens de stock ○ Available under request | Disponível sobre consulta | Disponible bajo consulta Insert order code = (1) Geometry Code + (2) Grade Code

SPARE PARTS | Complementos | Repuestos

Cutter ØDc	Insert Screw	Key (Torx)	Order separately		Retaining Screw
			Key (Torx - Nm)	Torque Value	
W20290 - 32-40	P0451001	XT20	DT2050	5	-
A20290 - 40-80	P0451001	XT20	DT2050	5	-
A20290 - 100	P0451001	PT20	DT2050	5	D1603500
A20290 - 125	P0451001	PT20	DT2050	5	D2004000

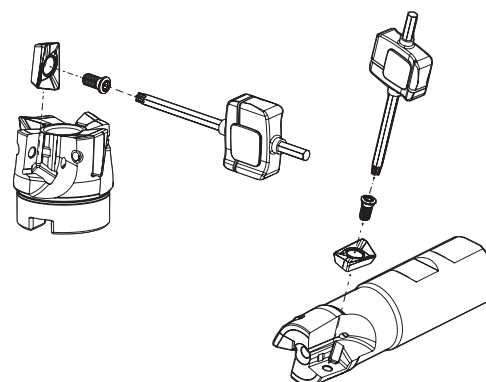

LINEPRO 20290

GRADES SELECTION GUIDE | Guia para selecção de graus | Tabla para selección de calidades

ISO	PSM	Material	HB (Brinell)	Grades							
				← Wear Resistance				Toughness →			
				PH0910	PH5705	PHP920	PHP930	PHH930	PH5740	PHS740	PH7740
P	1	Unalloyed Steel	125-220	●	●	●	●	●	●	●	●
	2	Low-Alloyed Steel	220-280			●	●			●	●
	3	High-Alloyed Steel	280-380			●	●			●	●
M	4	SS - Ferritic / Martensitic	200-330					●			●
	5	SS - Austenitic	200-330					●			●
	6	SS - Austenitic-ferritic (Duplex)	230-260					●			●
K	7	Malleable Cast Iron	130-230		●	●	●		●		●
	8	Grey Cast Iron	180-245		●	●	●		●		●
	9	Nodular Cast iron	160-250		●	●	●		●		●
N	10	Aluminium and Non Ferrous	30-130	●							
S	11	Heat Resistant Super Alloys	200-320					●			●

● Good Conditions

● Average Conditions

● Difficult Conditions

CHIP-BREAKER SELECTION GUIDE | Guia para aplicações do quebra-apanas | Guía para aplicación del rompevirutas

ISO	PSM	Material	HB (Brinell)	Chip-Breaker Application	
				1st choice	Difficult Operations
				P	1
2	Low-Alloyed Steel	220-280	XPET 17... LP		XPET 17... MP
3	High-Alloyed Steel	280-380	XPET 17... MP		-
M	4	SS - Ferritic / Martensitic	200-330	XPET 17... LS	XPET 17... LP
	5	SS - Austenitic	200-330	XPET 17... LS	XPET 17... LP
	6	SS - Austenitic-ferritic (Duplex)	230-260	XPET 17... LS	XPET 17... LP
K	7	Malleable Cast Iron	130-230	XPET 17... LP	XPET 17... MP
	8	Grey Cast Iron	180-245	XPET 17... MP	-
	9	Nodular Cast iron	160-250	XPET 17... MP	-
N	10	Aluminium and Non Ferrous	30-130	XPET 17... LN	-
S	11	Heat Resistant Super Alloys	200-320	XPET 17... LS	XPET 17... LP

RECOMMENDED CUTTING CONDITIONS | Condições de corte recomendadas | Condiciones de corte recomendables

ISO	PSM	Material	HB (Brinell)	Vc (m/min)				
				← Wear Resistance				
				PH0910	PH5705	PHP920	PHP930	PHH930
P	1	Unalloyed Steel	125-220	-	-	180-250	160-230	-
	2	Low-Alloyed Steel	220-280	-	-	160-230	140-210	-
	3	High-Alloyed Steel	280-380	-	-	140-220	120-200	-
M	4	SS - Ferritic / Martensitic	200-330	-	-	-	-	140-210
	5	SS - Austenitic	200-330	-	-	-	-	120-170
	6	SS - Austenitic-ferritic (Duplex)	230-260	-	-	-	-	100-150
K	7	Malleable Cast Iron	130-230	-	160-290	160-270	-	-
	8	Grey Cast Iron	180-245	-	170-320	140-250	-	-
	9	Nodular Cast iron	160-250	-	140-200	120-210	-	-
N	10	Aluminium and Non Ferrous	30-130	100-2000	-	-	-	-
S	11	Heat Resistant Super Alloys	200-320	-	-	-	-	30-110

(Note 1) Cutting conditions ae/DC=70%

(Note 2) Cutting conditions should be adjusted according to the machine and work rigidity.

(Note 3):

Operation	ae	Vc & fz	ap (mm)
Slotting	100%	<20%	2,0-6,0
Shouldering	<50%	>8%	7,0-13,0
	≤25%	>12%	13,0-16,0

(Note 4) It's possible to occur vibrations in certain cases.

Please reduce depth of cut and / or reduce cutting conditions in following cases:

- When using long shank;
- When using long tool overhang with arbor type;
- When application has poor clamping rigidity or when using a low rigidity machine.

RAMPING AND HELICAL INTERPOLATION

Descida em rampa e interpolação helicoidal | Bajada en rampa e interpolación circular

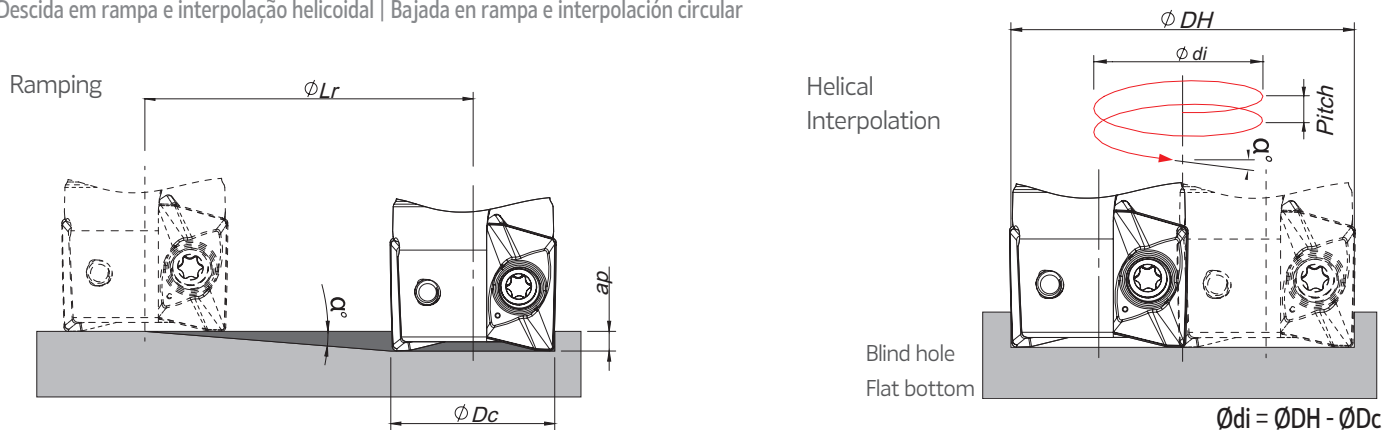

ϕD_c	Ramping			Helical Interpolation		
	Max Ramp a°	Max a_p	Min L_r	Diameter for Blind Hole, Flat Bottom Face (1)		Max Pitch/Rev.
				ϕDH_{min}	ϕDH_{max}	
32	3,8	17,0	255,9	58,8 -	- 62,4	5,6 6,3
40	2,7	17,0	360,5	74,8 -	- 78,4	5,2 5,7
50	2,0	17,0	486,8	94,8 -	- 98,4	4,9 5,3
63	1,5	17,0	649,2	120,8 -	- 124,4	4,8 5,0
80	1,0	17,0	973,9	154,8 -	- 158,4	4,1 4,3
100	0,8	17,0	1217,5	194,8 -	- 198,4	4,2 4,3
125	0,7	17,0	1498,4	244,8 -	- 248,4	4,3 4,4

(1) using LP insert with radius 0,8 mm

Note: During helical interpolation do not exceed maximum pitch

When using HF insert or other different insert radius to calculate the ϕDH_{min} and ϕDH_{max} use the equation below:

- Minimum Diameter: $\phi DH_{min} = 2 \times (\phi D_c - (R \text{ corner radius} + F \text{ width of edge wiper}))$

- Maximum Diameter: $\phi DH_{max} = 2 \times (\phi D_c - R \text{ corner radius})$

Vc (m/min)			Feed fz (mm/t)			
Toughness →						
PH5740	PHS740	PH7740	XPET 17... LP	XPET 17... MP	XPET 17... LN	XPET 17... LS
-	140-220	140-200	0,10-0,35	0,10-0,35	-	-
-	120-200	130-180	0,10-0,35	0,10-0,35	-	-
-	100-190	100-170	0,10-0,30	0,10-0,30	-	-
-	-	130-180	0,10-0,30	-	-	0,10-0,35
-	-	110-160	0,10-0,30	-	-	0,10-0,30
-	-	90-150	0,10-0,25	-	-	0,10-0,25
160-260	-	140-220	0,10-0,35	0,10-0,35	-	-
140-240	-	120-210	0,10-0,35	0,10-0,35	-	-
120-200	-	100-190	0,10-0,30	0,10-0,30	-	-
-	-	-	-	-	0,10-0,35	-
-	-	30-100	0,10-0,20	-	-	0,10-0,20

LINEPRO 20090 | 20190 | 20290

XPET 06...-LN TEST REPORT

Milling cutter
025R20090-07-04-M12030

Insert
XPET 060204 PDFR-LN

Grade
PH0910

43% productivity improvement

Machining time
100 (min/per edge)



Milling cutter
Competitor Equivalent product

Insert
Competitor Equivalent product

Grade
Competitor Equivalent product

Machining time
70 (min/per edge)

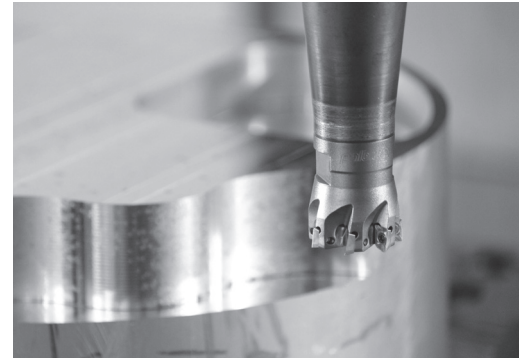
Work material: AISi10Mg	
Cutting speed: Vc (m/min)	650
Feed per tooth: fz (mm/t)	0,08
Depth of cut: ap (mm)	1,00
Width of cut: ae (mm)	15
Method of machining	Shoulder milling
Coolant	Air

XPHW 06...-MH TEST REPORT

Milling cutter
020R20090-05-04-M10030

Insert
XPHW 060208-MH

Grade
PH7603

32% productivity improvement

Machining time
859 (min/per edge)



Milling cutter
Competitor Equivalent product

Insert
Competitor Equivalent product

Grade
Competitor Equivalent product

Machining time
587 (min/per edge)

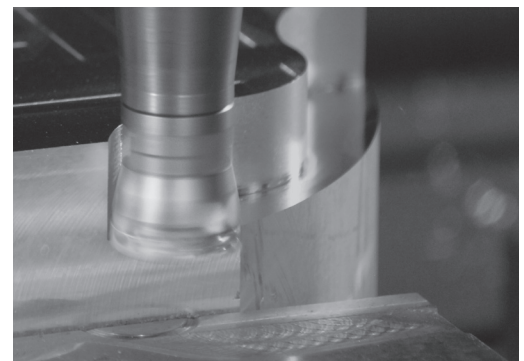
Work material: 40CrMnNiMo8 (1.2738) - (34-38 HRC)	
Cutting speed: Vc (m/min)	300
Feed per tooth: fz (mm/t)	0,10
Depth of cut: ap (mm)	0,18
Width of cut: ae (mm)	0,20
Method of machining	Shoulder milling
Coolant	Air

XPET 17.. = MP PHS740 TEST REPORT

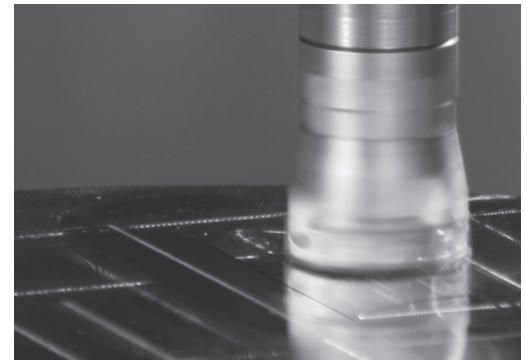
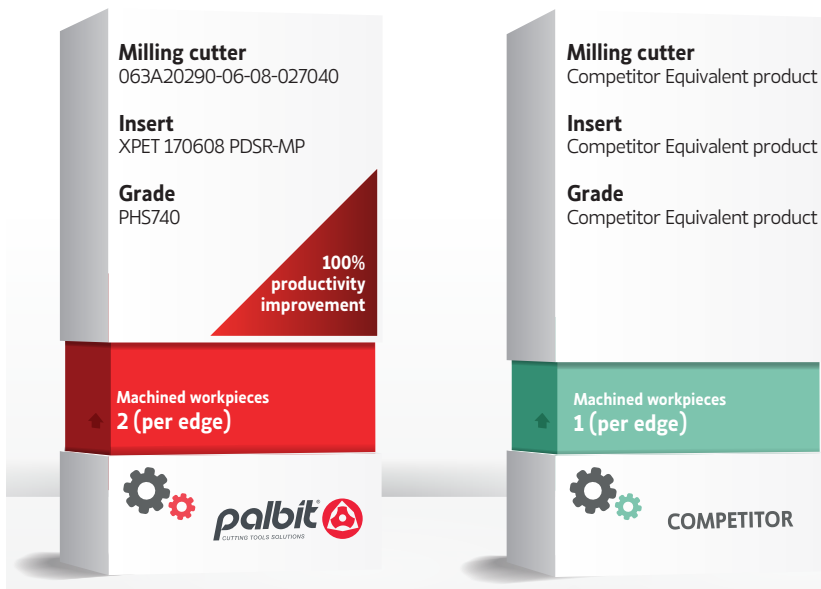

Work material: 1.0037 Structural Steel
Unstable weld design and heavy interrupted cutting areas

Cutting speed: Vc (m/min)	400
Feed per tooth: fz (mm/t)	0,20
Depth of cut: ap (mm)	2-3
Width of cut: ae (mm)	60
Method of machining	Sholder milling
Coolant	Yes



LINEPRO
20090 | 20190 | 20290

HEADQUARTERS

PALBIT, S.A.

P.O.Box 4 - Palhal

3854-908 - Branca ALB - Portugal

T (+351) 234 540 300 | F (+351) 234 540 301

palbit@palbit.pt | www.palbit.pt

Branch office:

PALBIT México

Emerson 150. Int.803-804. Colonia Chapultepec

Morales Delagación Miguel Hidalgo

C.P. 11570 México DF

T (+52) 5555 454 543 | F (+52) 5552 509 190

info@palbit.com.mx | www.palbit.com.mx



SINCE 1916