

The most reliable  
deep-hole drilling system

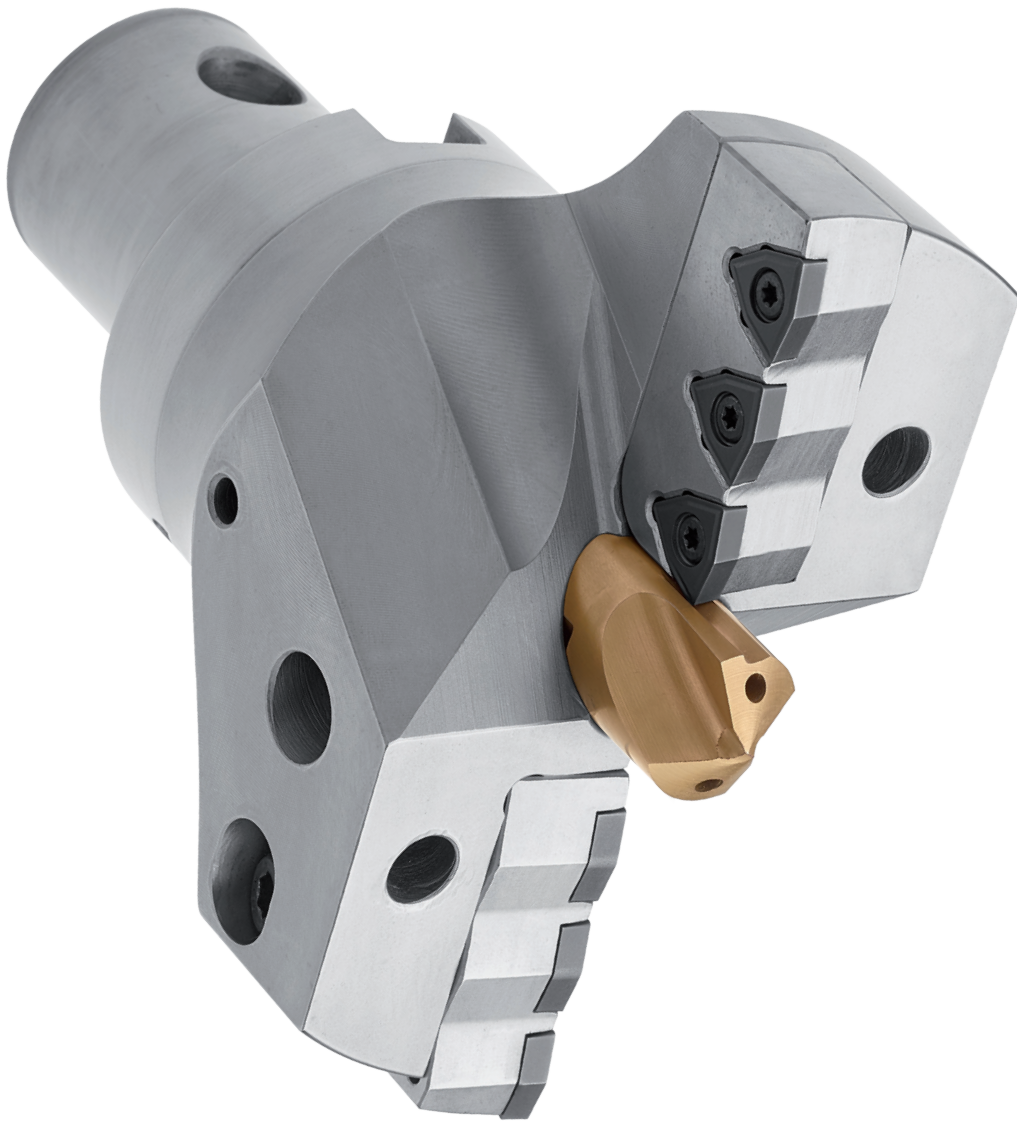

VORTEX DRILL  
MDO 10D



INSERT SIZE  
03 | 04 | 05  
06 | 08 WCKX



INSERT SIZE  
05 | 06 WCKX-LC



SINCE 1916

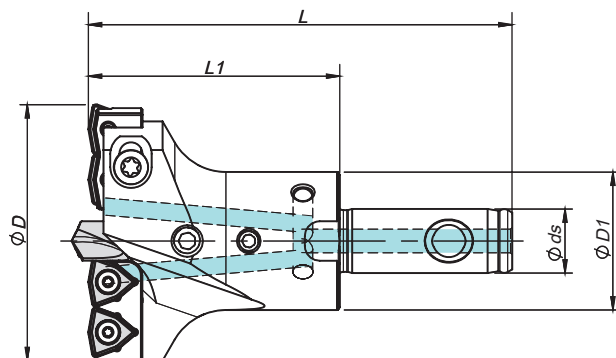
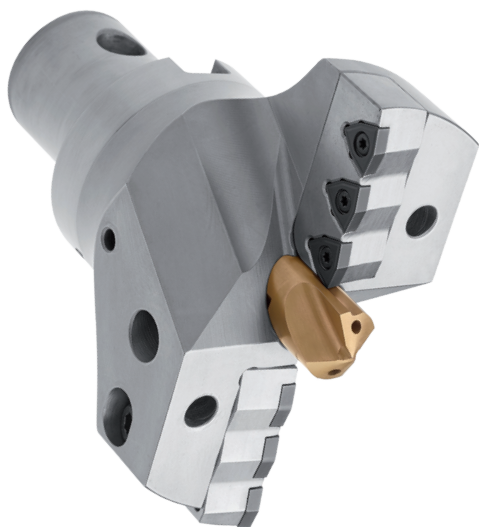

Order separately

Order code Código	Referenc Referência Referencia	Dimensions   Dimensões Dimensiones (mm)					Cartridge	Insert	Insert Screw	Torx key	Pilot drill	Stock
		ØD	Ø ds	L1	L	ØD1						

### 2 INSERTS PER CARTRIDGE

184031000	MDO 04505013	45-50	13	50	85	28	MDC 045050-I/O	WCKX 030204	P0220500	XT07	MDP 3510	☉
184031100	MDO 05005513	50-55	13	50	85	28	MDC 050055-I/O	WCKX 030204	P0220500	XT07	MDP 3510	☉
184031200	MDO 05506016	55-60	16	60	100	32	MDC 055060-I/O	WCKX 040204	P0250503	XT08	MDP 3812	☉
184031300	MDO 06006516	60-65	16	60	100	32	MDC 060065-I/O	WCKX 050308	P0300701	XT08	MDP 3812	☉
184031500	MDO 06507016	65-70	16	60	100	32	MDC 065070-I/O	WCKX 050308	P0300701	XT08	MDP 3812	☉
184032400	MDO 07007522	70-75	22	70	115	40	MDC 070075-I/O	WCKX 050308	P0300701	XT08	MDP 3812	☉
184032500	MDO 07508022	75-80	22	70	115	40	MDC 075080-I/O	WCKX 06T308	P0350903	XT15	MDP 4516	☉
184032600	MDO 08008522	80-85	22	70	115	40	MDC 080085-I/O	WCKX 06T308	P0350903	XT15	MDP 4516	☉
184032700	MDO 08509027	85-90	27	70	120	48	MDC 085090-I/O	WCKX 06T308	P0350903	XT15	MDP 4516	☉
184032800	MDO 09009527	90-95	27	70	120	48	MDC 090095-I/O	WCKX 06T308	P0350903	XT15	MDP 4516	☉
184032900	MDO 09510027	95-100	27	70	120	48	MDC 095100-I/O	WCKX 06T308	P0350903	XT15	MDP 4516	☉

### 3 INSERTS PER CARTRIDGE

184033000	MDO 10010532	100-105	32	80	130	58	MDC 100105-I/O	WCKX 050308	P0300701	XT08	MDP 4520	☉
184066400	MDO 10511032	105-110	32	80	130	58	MDC 105110-I/O	WCKX 06T308	P0350903	XT15	MDP 4520	☉
184066500	MDO 11011532	110-115	32	80	130	58	MDC 110115-I/O	WCKX 06T308	P0350903	XT15	MDP 4520	☉
184066600	MDO 11512040	115-120	40	90	145	70	MDC 115120-I/O	WCKX 06T308	P0350903	XT15	MDP 4520	☉
184066700	MDO 12012540	120-125	40	90	145	70	MDC 120125-I/O	WCKX 06T308	P0350903	XT15	MDP 5625	☉
184066800	MDO 12513040	125-130	40	90	145	70	MDC 125130-I/O	WCKX 06T308	P0350903	XT15	MDP 5625	☉
184066900	MDO 13013540	130-135	40	90	145	70	MDC 130135-I/O	WCKX 06T308	P0350903	XT15	MDP 5625	☉
184067000	MDO 13514040	135-140	40	90	145	70	MDC 135140-I/O	WCKX 06T308	P0350903	XT15	MDP 5625	☉
184067100	MDO 14015050	140-150	50	100	160	80	MDC 140150-I/O	WCKX 080408	P0401101	XT15	MDP 5625	☉
184067200	MDO 15016050	150-160	50	100	160	80	MDC 150160-I/O	WCKX 080408	P0401101	XT15	MDP 5625	☉
184067300	MDO 16017050	160-170	50	100	160	80	MDC 160170-I/O	WCKX 080408	P0401101	XT15	MDP 6830	☉
184067400	MDO 17018050	170-180	50	100	160	80	MDC 170180-I/O	WCKX 080408	P0401101	XT15	MDP 6830	☉

☉ Stock item | Produto de stock | Itens de stock      ○ Available under request | Disponível sobre consulta | Disponible bajo consulta

Drills with larger diameter available under request with a minimum order quantity.

**Note:** This type of drills are supplied without pilot drills. Please order them separately.

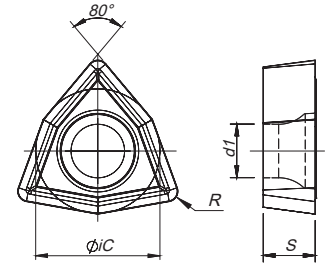

(1) Geometry code	(2) Grade code	P				M		K		S		Dimensions Dimensões Dimensiones (mm)			
		PVD				PVD		CVD		PVD		iC	S	d1	R
		68	66	I5	78	68	66	68	66	68	66				
	ISO Reference	PH6920	PH6930	PH6740	PH6125	PH6920	PH6930	PH6920	PH6930	PH6920	PH6930				
1140300	WCKX 02T104	⊗	⊗	○	○	⊗	⊗	⊗	⊗	⊗	⊗	4,76	1,98	2,00	0,4
1140276	WCKX 030204	⊗	⊗	○	○	⊗	⊗	⊗	⊗	⊗	⊗	5,56	2,38	2,55	0,4
1140277	WCKX 040204	⊗	⊗	○	○	⊗	⊗	⊗	⊗	⊗	⊗	6,35	2,38	2,85	0,4
1140278	WCKX 050308	⊗	⊗	○	○	⊗	⊗	⊗	⊗	⊗	⊗	7,94	3,18	3,50	0,8
1140279	WCKX 06T308	⊗	⊗	○	○	⊗	⊗	⊗	⊗	⊗	⊗	9,55	3,97	4,10	0,8
1140280	WCKX 080408	⊗	⊗	○	○	⊗	⊗	⊗	⊗	⊗	⊗	12,70	4,76	5,60	0,8

⊗ Stock item | Produto de stock | Itens de stock

○ Available under request | Disponível sobre consulta | Disponible bajo consulta

Insert order code = (1) Geometry Code + (2) Grade Code

## WCKX-LC for low carbon steels | Inserts | Pastilhas | Plaquetas

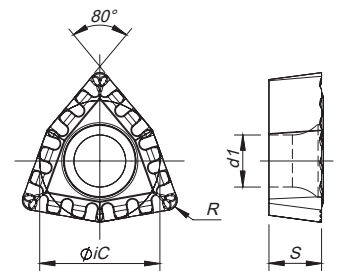

(1) Geometry code	(2) Grade code	P		Dimensions Dimensões Dimensiones (mm)			
		PVD		iC	S	d1	R
		68	66				
	ISO Reference	PH6920	PH6930				
1142068	WCKX 050308-LC	⊗	⊗	7,94	3,18	3,50	0,8
1142069	WCKX 06T308-LC	⊗	⊗	9,55	3,97	4,10	0,8

⊗ Stock item | Produto de stock | Itens de stock

○ Available under request | Disponível sobre consulta | Disponible bajo consulta

Insert order code = (1) Geometry Code + (2) Grade Code

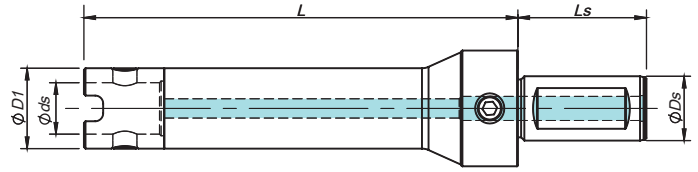

New version / Standard version\*

Øds	Ls	BP / SP
32	70	PT - 1/4
40	80	PT - 1/4
50	80 / 100	PT - 1/4

Order separatly

Order code Código	Reference Referência Referencia	Dimensions   Dimensões   Dimensiones (mm)				Drive Ring 	Stock
		ØDs	Øds	ØD1	L		
184121900	MDS 32115130	32	13	28	115	MDR 1028	⊗
184253700	MDS 32200130	32	13	28	200	MDR 1028	⊗
184255400	MDS 32300130	32	13	28	300	MDR 1028	⊗
184122100	MDS 40125160	40	16	32	125	MDR 1032	⊗
184253800	MDS 40200160	40	16	32	200	MDR 1032	⊗
184255500	MDS 40300160	40	16	32	300	MDR 1032	⊗
184122300	MDS 40148220	40	22	40	148	MDR 1240	⊗
184122400	MDS 40200220	40	22	40	200	MDR 1240	⊗
184122500	MDS 40300220	40	22	40	300	MDR 1240	⊗
184122600	MDS 40168270	40	27	48	168	MDR 1248	⊗
184122700	MDS 40300270	40	27	48	300	MDR 1248	⊗
184122800	MDS 40186320	40	32	58	186	MDR 1458	⊗
184122900	MDS 40300320	40	32	58	300	MDR 1458	⊗
184123000	MDS 50186400	50	40	70	186	MDR 1470	⊗
184123100	MDS 50300400	50	40	70	300	MDR 1470	⊗
184123200	MDS 50184500	50	50	80	184	MDR 1680	⊗
184123300	MDS 50300500	50	50	80	300	MDR 1680	⊗

⊗ Stock item | Produto de stock | Itens de stock      ○ Available under request | Disponível sobre consulta | Disponible bajo consulta

Note: This type of shank are supplied without drive ring. Please order them separately.

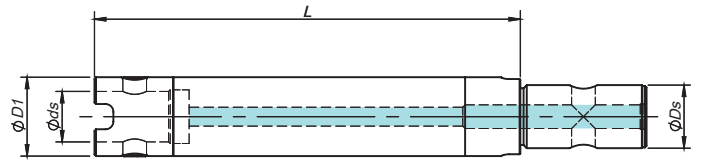

Order separately

Order code Código	Reference Referência Referencia	Dimensions   Dimensões   Dimensiones (mm)				 Drive Ring	Stock
		ØDs	Øds	ØD1	L		
184023500	MDE 13115280	13	13	28	115	MDR 1028	⊗
184023600	MDE 13150280	13	13	28	150	MDR 1028	⊗
184023700	MDE 13200280	13	13	28	200	MDR 1028	⊗
184021800	MDE 13300280	13	13	28	300	MDR 1028	⊗
184023800	MDE 16115320	16	16	32	115	MDR 1032	⊗
184021900	MDE 16200320	16	16	32	200	MDR 1032	⊗
184023900	MDE 16300320	16	16	32	300	MDR 1032	⊗
184024000	MDE 22113400	22	22	40	113	MDR 1240	⊗
184024100	MDE 22200400	22	22	40	200	MDR 1240	⊗
184024200	MDE 22300400	22	22	40	300	MDR 1240	⊗
184024300	MDE 27113480	27	27	48	113	MDR 1248	⊗
184024400	MDE 27200480	27	27	48	200	MDR 1248	⊗
184024500	MDE 27300480	27	27	48	300	MDR 1248	⊗
184024600	MDE 32186580	32	32	58	186	MDR 1458	⊗
184024700	MDE 32300580	32	32	58	300	MDR 1458	⊗
184024800	MDE 40186700	40	40	70	186	MDR 1470	⊗
184024900	MDE 40300700	40	40	70	300	MDR 1470	⊗
184025000	MDE 40500700	40	40	70	500	MDR 1470	⊗
184025100	MDE 50204800	50	50	80	204	MDR 1680	⊗
184025200	MDE 50300800	50	50	80	300	MDR 1680	⊗
184025300	MDE 50500800	50	50	80	500	MDR 1680	⊗

⊗ Stock item | Produto de stock | Itens de stock      ○ Available under request | Disponível sobre consulta | Disponible bajo consulta

Note: This type of shank are supplied without drive ring. Please order them separately.

# SPARE PARTS

## MDO CARTRIDGE

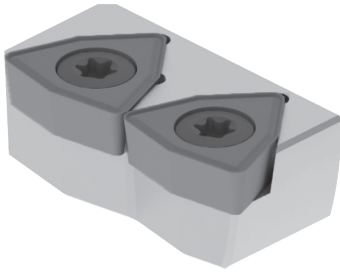

ØD	Inner Cartridge		Outer Cartridge		Insert	Insert Screw	Torx key	For Drill
	Order Code	Reference	Order Code	Reference				
<b>2 INSERTS PER CARTRIDGE</b>								
45-50	184062000	MDC 045050-I	184252600	MDC 045050-O	WC... 030204	P0220500	XT07	MDO 04505013
50-55	184250400	MDC 050055-I	184252700	MDC 050055-O	WC... 030204	P0220500	XT07	MDO 05005513
55-60	184250500	MDC 055060-I	184252800	MDC 055060-O	WC... 040204	P0250503	XT08	MDO 05506016
60-65	184250600	MDC 060065-I	184252900	MDC 060065-O	WC... 050308	P0300701	XT08	MDO 06006516
65-70	184250700	MDC 065070-I	184253000	MDC 065070-O	WC... 050308	P0300701	XT08	MDO 06507016
70-75	184250800	MDC 070075-I	184063700	MDC 070075-O	WC... 050308	P0300701	XT08	MDO 07007522
75-80	184250900	MDC 075080-I	184063800	MDC 075080-O	WC... 06T308	P0350903	XT15	MDO 07508022
80-85	184251000	MDC 080085-I	184063900	MDC 080085-O	WC... 06T308	P0350903	XT15	MDO 08008522
85-90	184251100	MDC 085090-I	184064000	MDC 085090-O	WC... 06T308	P0350903	XT15	MDO 08509027
90-95	184251200	MDC 090095-I	184064100	MDC 090095-O	WC... 06T308	P0350903	XT15	MDO 09009527
95-100	184251300	MDC 095100-I	184064200	MDC 095100-O	WC... 06T308	P0350903	XT15	MDO 09510027
<b>3 INSERTS PER CARTRIDGE</b>								
100-105	184251400	MDC 100105-I	184064300	MDC 100105-O	WC... 050308	P0300701	XT08	MDO 10010532
105-110	184251500	MDC 105110-I	184253100	MDC 105110-O	WC... 06T308	P0350903	XT15	MDO 10511032
110-115	184251600	MDC 110115-I	184253200	MDC 110115-O	WC... 06T308	P0350903	XT15	MDO 11011532
115-120	184251700	MDC 115120-I	184253300	MDC 115120-O	WC... 06T308	P0350903	XT15	MDO 11512040
120-125	184251800	MDC 120125-I	184253400	MDC 120125-O	WC... 06T308	P0350903	XT15	MDO 12012540
125-130	184251900	MDC 125130-I	184253500	MDC 125130-O	WC... 06T308	P0350903	XT15	MDO 12513040
130-135	184252000	MDC 130135-I	184068900	MDC 130135-O	WC... 06T308	P0350903	XT15	MDO 13013540
135-140	184252100	MDC 135140-I	184069000	MDC 135140-O	WC... 06T308	P0350903	XT15	MDO 13514040
140-150	184252200	MDC 140150-I	184253600	MDC 140150-O	WC... 080408	P0401101	XT15	MDO 14015050
150-160	184252300	MDC 150160-I	184069200	MDC 150160-O	WC... 080408	P0401101	XT15	MDO 15016050
160-170	184252400	MDC 160170-I	184069300	MDC 160170-O	WC... 080408	P0401101	XT15	MDO 16017050
170-180	184252500	MDC 170180-I	184069400	MDC 170180-O	WC... 080408	P0401101	XT15	MDO 17018050

# SCREWS

Vortex Drill	(3) Fixing Screw for Pilot Drill		(4) Clamping Bolt for Pilot Drill		(5) Adjustment Screw for Pilot Drill		(7) Screw for Cartridge	
	Order Code	Screw	Order Code	Screw	Order Code	Screw	Order Code	Screw
MDO 04505013	290040100	P0400875	290040400	P0601075	290041400	P0601076	290042500	P0401078
MDO 05005513	290040100	P0400875	290040400	P0601075	290041400	P0601076	290042500	P0401078
MDO 05506016	290040100	P0400875	290040600	P0801275	290041500	P0801576	290042700	P0501278
MDO 06006516	290040200	P0500875	290040600	P0801275	290041500	P0801576	290042700	P0501278
MDO 06507016	290040200	P0500875	290040600	P0801275	290041500	P0801576	290042700	P0501278
MDO 07007522	290040200	P0500875	290040700	P0801575	290041500	P0801576	290042700	P0501278
MDO 07508022	290040400	P0601075	290040900	P1002075	290041600	P1001676	290043000	P0601279
MDO 08008522	290040400	P0601075	290040900	P1002075	290041600	P1001676	290043100	P0601479
MDO 08509027	290040400	P0601075	290040900	P1002075	290041700	P1001876	290043600	P0601679
MDO 09009527	290040400	P0601075	290040900	P1002075	290041700	P1001876	290043600	P0601679
MDO 09510027	290040400	P0601075	290040900	P1002075	290041700	P1001876	290043600	P0601679
MDO 10010532	290040400	P0601075	290041000	P1202075	290041800	P1202076	290043300	P0801879
MDO 10511032	290040400	P0601075	290041000	P1202075	290041800	P1202076	290043300	P0801879
MDO 11011532	290040400	P0601075	290041000	P1202075	290041800	P1202076	290043300	P0801879
MDO 11512040	290040400	P0601075	290041100	P1202575	290041900	P1402076	290043400	P0802079
MDO 12012540	290040400	P0601075	290041200	P1402575	290041900	P1402076	290043500	P0802579
MDO 12513040	290040400	P0601075	290041200	P1402575	290041900	P1402076	290043500	P0802579
MDO 13013540	290040400	P0601075	290041200	P1402575	290041900	P1402076	290043500	P0802579
MDO 13514040	290040400	P0601075	290041200	P1402575	290041900	P1402076	290043500	P0802579
MDO 14015050	290040400	P0601075	290041200	P1402575	290041900	P1402076	290043500	P0802579
MDO 15016050	290040400	P0601075	290041200	P1402575	290041900	P1402076	290043500	P0802579
MDO 16017050	290040400	P0601075	290041300	P1602575	290041900	P1402076	290043500	P0802579
MDO 17018050	290040400	P0601075	290041300	P1602575	290041900	P1402076	290043500	P0802579

(9) Fixation Screw for MDS Shank, MDE Extension, MDM Reducer		
ØD / ØD1	Order Code Código	Screw
28	290032400	P0801280
32	290032400	P0801280
40	290032500	P1001580
48	290032600	P1201880
58	290039600	P1202080
70	290032800	P1602780
80	290032800	P1602780

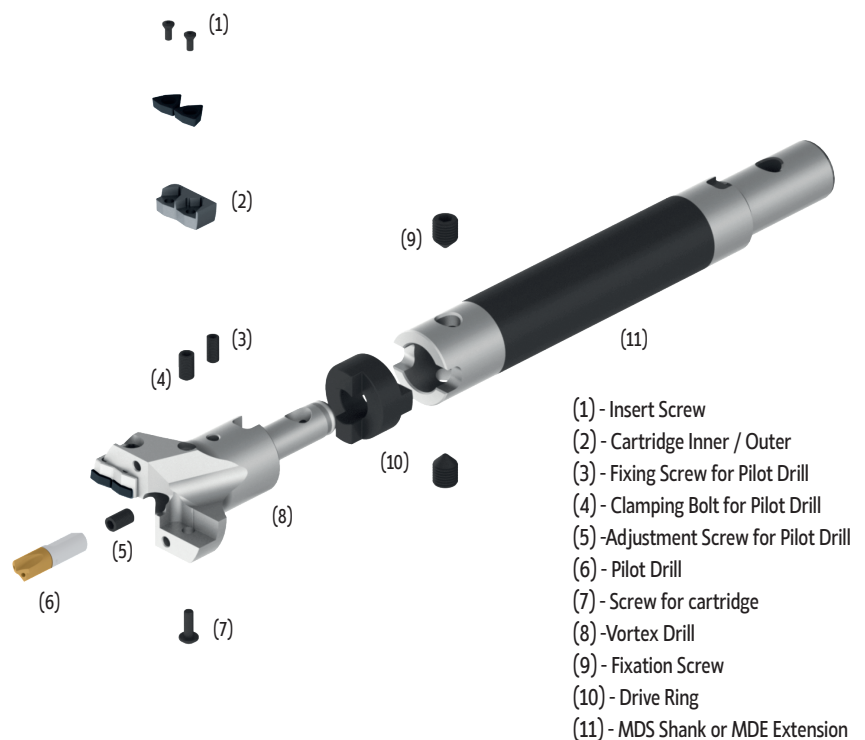

# SPARE PARTS

## PILOT DRILL

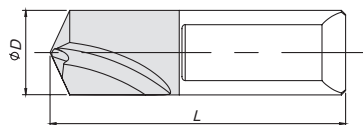

Shank Type

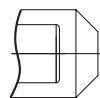

A (with cone)

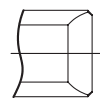

B (with chamfer)

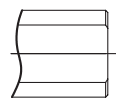

C

Order Code	Reference	Dimensions (mm)		Type	Oil Hole	For Drill
		$\phi D$	L			
184033100	MDP 3510	10	35	B	✓	MDO ( $\phi 45$ - $\phi 55$ )
184033200	MDP 3812	12	38	B	✓	MDO ( $\phi 55$ - $\phi 75$ )
184033300	MDP 4516	16	45	B	✓	MDO ( $\phi 75$ - $\phi 100$ )
184033400	MDP 4520	20	45	C	✓	MDO ( $\phi 100$ - $\phi 120$ )
184033500	MDP 5625	25	56	C	✓	MDO ( $\phi 120$ - $\phi 160$ )
184033600	MDP 6830	30	68	C	✓	MDO ( $\phi 160$ - $\phi 180$ )

## PILOT DRILL ADJUSTEMENT | Ajuste da Broca Piloto | Ajuste de la Broca Piloto

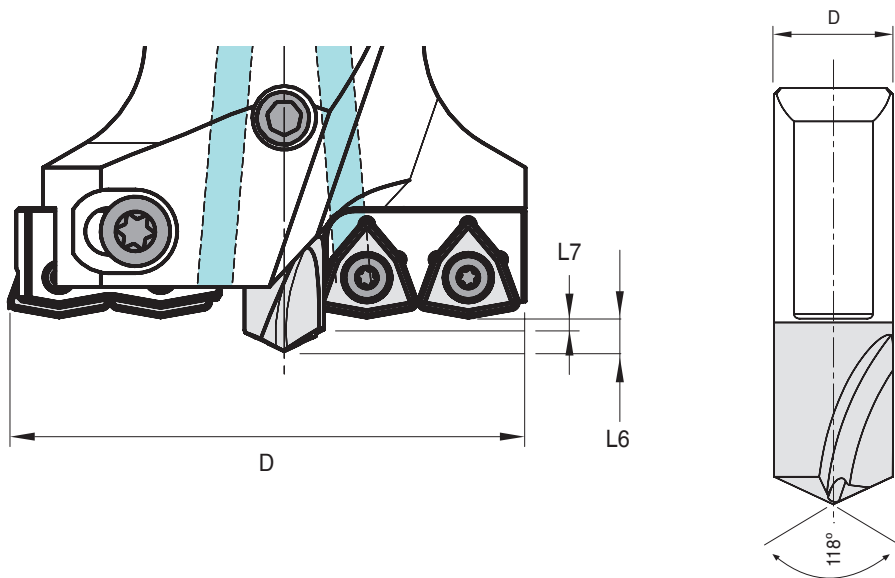

Dc (mm)	2D to 4D		4D to 6D		> 6D	
	L7	L6	L7	L6	L7	L6
45-55	1,6	4,0	1,8	4,2	2,0	4,4
55-75	1,8	5,4	2,0	5,6	2,2	5,8
75-100	2,2	6,5	2,5	6,8	2,8	7,1
100-120	2,4	7,7	2,8	8,1	3,2	8,5
120-170	3,2	9,9	3,6	10,3	4,0	10,7
170-180	3,5	12,2	3,9	12,6	4,3	13,0



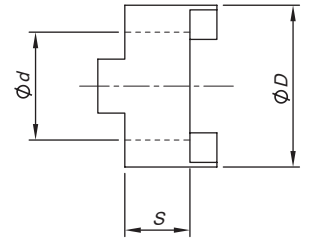

## DRIVE RING

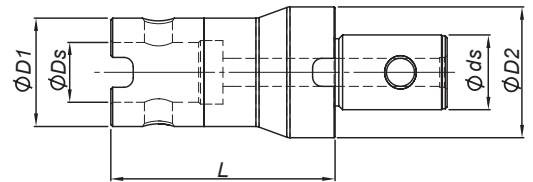
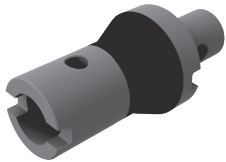

Order Code	Reference	Dimensions (mm) Dimensões (mm) Dimensiones (mm)		
		ØD	Ød	S
184021600	MDR 1028	28	13	10
184021700	MDR 1032	32	16	10
184022100	MDR 1240	40	22	12
184022200	MDR 1248	48	27	12
184022300	MDR 1458	58	32	14
184022400	MDR 1470	70	40	14
184022500	MDR 1680	80	50	16

## MDM = REDUCER



Order Code	Reference	Dimensions / Dimensões / Dimensiones (mm)					Drive Ring D1	Drive Ring D2
		ØDs	Øds	ØD1	ØD2	L		
184253900	MDM 16100130	13	16	28	32	100	MDR 1028	MDR 1032
184254000	MDM 22100160	16	22	32	40	100	MDR 1032	MDR 1240
184254100	MDM 27100220	22	27	40	48	100	MDR 1240	MDR 1248
184254200	MDM 32100130	13	32	28	58	100	MDR 1028	MDR 1458
184254300	MDM 32100160	16	32	32	58	100	MDR 1032	MDR 1458
184254400	MDM 32100220	22	32	40	58	100	MDR 1240	MDR 1458
184254500	MDM 32100270	27	32	48	58	100	MDR 1248	MDR 1458
184254600	MDM 40100320	32	40	58	70	100	MDR 1458	MDR 1470
184254700	MDM 50080130	13	50	28	80	80	MDR 1028	MDR 1680
184254800	MDM 50080160	16	50	32	80	80	MDR 1032	MDR 1680
184254900	MDM 50080220	22	50	40	80	80	MDR 1240	MDR 1680
184255000	MDM 50080270	27	50	48	80	80	MDR 1248	MDR 1680
184255100	MDM 50080320	32	50	58	80	80	MDR 1458	MDR 1680
184250200	MDM 50150400	40	50	70	80	150	MDR 1470	MDR 1680

# SPARE PARTS

## Fixing Screw and Clamping Bolt for Pilot Drill (DIN 916)

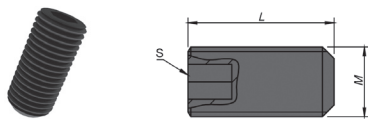

Order Code Código	Screw	Dimensions (mm) Dimensões (mm) Dimensiones (mm)		
		M	L	S
290040100	P0400875	M4 x 0,7	8,0	2,0
290040200	P0500875	M5 x 0,8	8,0	2,5
290040300	P0501075	M5 x 0,8	10,0	2,5
290040400	P0601075	M6 x 1,0	10,0	3,0
290040500	P0601275	M6 x 1,0	12,0	3,0
290040600	P0801275	M8 x 1,25	12,0	4,0
290040700	P0801575	M8 x 1,25	15,0	4,0
290040800	P1001575	M10 x 1,5	15,0	5,0
290040900	P1002075	M10 x 1,5	20,0	5,0
290041000	P1202075	M12 x 1,75	20,0	6,0
290041100	P1202575	M12 x 1,75	25,0	6,0
290041200	P1402575	M14 x 2,0	25,0	6,0
290041300	P1602575	M16 x 2,0	25,0	8,0

## Adjustment Screw for Pilot Drill (DIN 916 w/ hole)

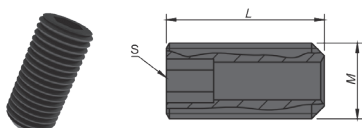

Order Code Código	Screw	Dimensions (mm) Dimensões (mm) Dimensiones (mm)		
		M	L	S
290041400	P0601076	M6 x 1,0	10,0	3,0
290041500	P0801576	M8 x 1,25	15,0	4,0
290041600	P1001676	M10 x 1,5	16,0	5,0
290041700	P1001876	M10 x 1,5	18,0	5,0
290041800	P1202076	M12 x 1,75	20,0	6,0
290041900	P1402076	M14 x 2,0	20,0	6,0

### Screw for Cartridge (ISO 7380)

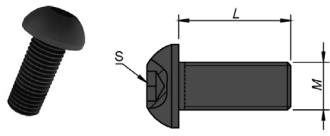

Order Code Código	Screw	Dimensions (mm) Dimensões (mm) Dimensiones (mm)		
		M	L	S
290042500	P0401078	M4 x 0,7	10,0	2,0
290042700	P0501278	M5 x 0,8	12,0	2,5

### Screw for Cartridge (DIN 912)

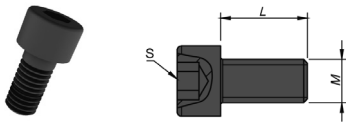

Order Code Código	Screw	Dimensions (mm) Dimensões (mm) Dimensiones (mm)		
		M	L	S
290043000	P0601279	M6 x 1,0	12,0	2,5
290043100	P0601479	M6 x 1,0	14,0	3,0
290043600	P0601679	M6 x 1,0	16,0	3,0
290043300	P0801879	M8 x 1,25	18,0	4,0
290043400	P0802079	M8 x 1,25	20,0	4,0
290043500	P0802579	M8 x 1,25	25,0	4,0

### Fixation Screw for MDS Shank, MDE Extension, MDM Reducer

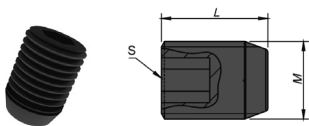

Order Code Código	Screw	Dimensions (mm) Dimensões (mm) Dimensiones (mm)		
		M	L	S
290032400	P0801280	M8	12,0	4,0
290032500	P1001580	M10	15,0	5,0
290032600	P1201880	M12	18,0	6,0
290039600	P1202080	M12	20,0	6,0
290032800	P1602780	M16	27,0	8,0

## Coated Carbide Grades

### PVD Grades

#### PH6920

P10-P35  
M10-M25  
K10-K30

Coated grade over a tough wear resistance substrate for general purpose machining.

#### PH6930

P20-P40  
M20-M30  
K20-K40

Grade suitable for applications with instability conditions. Excellent solution for medium cutting speed applications.

## Grades recommendation for drilling systems

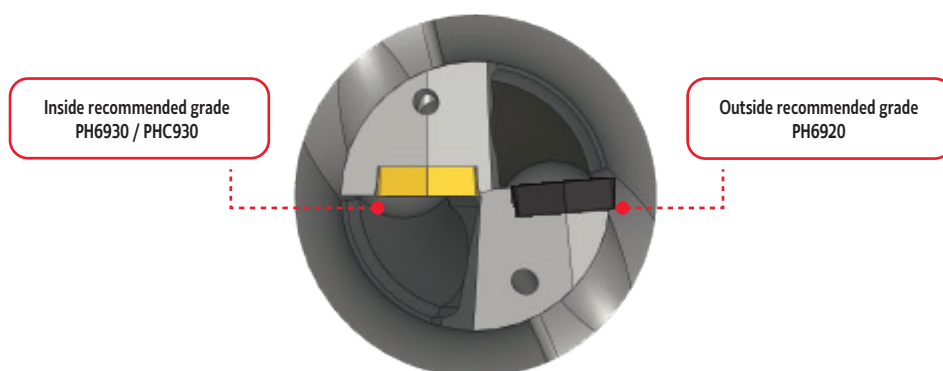

Note: This recommendation should be applied on High Alloy Steels, Stainless Steels and HRSA materials.

# VORTEX DRILLS = CUTTING PARAMETERS AND ADJUSTMENTS

Parâmetros de corte e ajustes | Condiciones de corte y ajustes

## Recommended Speeds and Feeds | Parâmetros de Corte Recomendados Recomendaciones de Datos de Corte

ISO	Material Group Grupo Materiais Grupo Materiales	Vc (m/min)	Ø45-55	Ø55-60	Ø60-75	Ø75-100	Ø100-105	Ø105-150	Ø150-180
<b>P</b>	UNALLOYED STEEL (-0,25%)	120-180	0,06-0,10	0,07-0,11	0,08-0,12	0,10-0,14	0,14-0,20	0,08-0,12	0,10-0,14
	LOW-ALLOY STEEL (0,25%-)	110-170	0,06-0,10	0,07-0,11	0,08-0,12	0,10-0,14	0,12-0,18	0,08-0,12	0,10-0,14
	LOW-ALLOY STEEL (-HB300)	90-130	0,06-0,10	0,07-0,11	0,08-0,12	0,10-0,14	0,12-0,18	0,08-0,12	0,10-0,14
	HIGH-ALLOY STEEL (HB300-)	60-100	0,05-0,07	0,05-0,07	0,06-0,08	0,06-0,10	0,09-0,13	0,06-0,08	0,06-0,10
<b>M</b>	STAINLESS STEEL	60-110	0,04-0,07	0,04-0,11	0,06-0,12	0,08-0,14	0,10-0,18	0,06-0,12	0,08-0,14
<b>K</b>	GREY CAST IRON	120-180	0,07-0,13	0,07-0,15	0,08-0,16	0,10-0,18	0,12-0,22	0,08-0,16	0,10-0,18
	CAST IRON WITH NODULAR CAST	100-180	0,04-0,13	0,07-0,15	0,08-0,16	0,10-0,25	0,12-0,26	0,08-0,16	0,10-0,25

## Power Requirements | Requisitos de Potência | Requisitos de Potencia

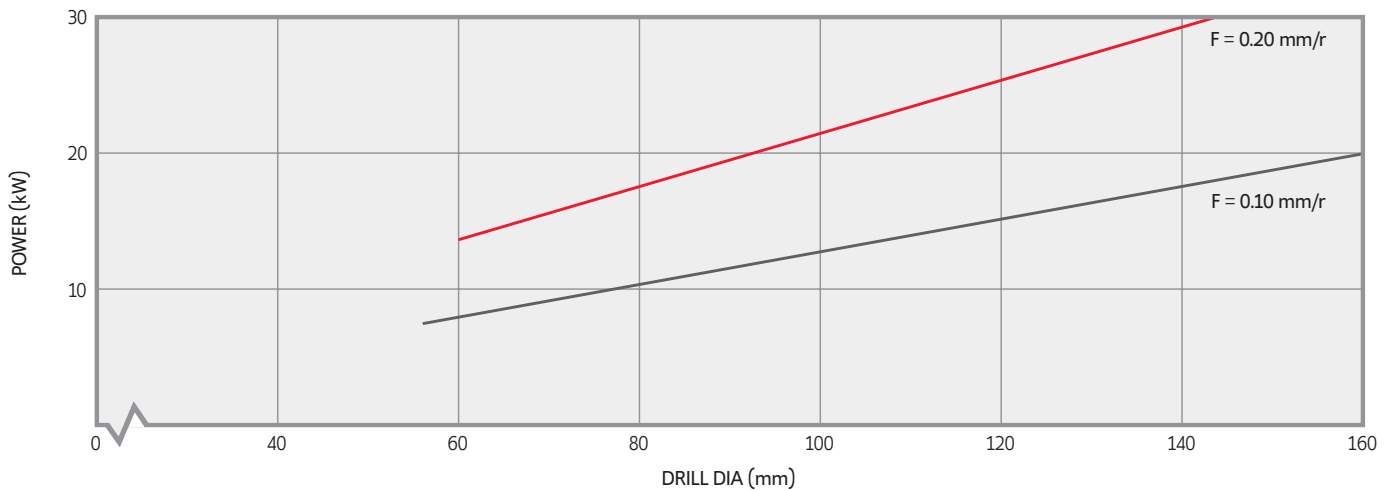

\* These chart is based on machining experiences using steels with a hardness of 200-250HB and cutting speed of 100m/min.

## Coolant Application Chart | Tabela Aplicação de Refrigeração | Tabla Aplicación de Refrigerante

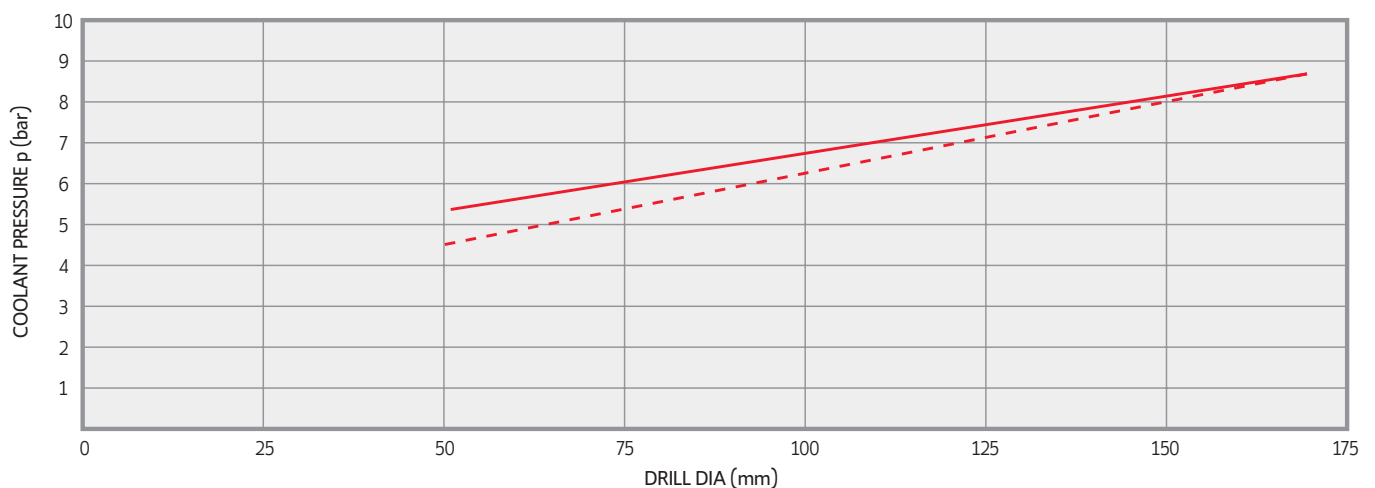

# VORTEX DRILLS = CUTTING PARAMETERS AND ADJUSTMENTS



Parâmetros de corte e ajustes | Condiciones de corte y ajustes

## Rules & Tips | Regras e Dicas | Normas e Consejos

WRONG	CORRECT	EN	PT	ES
		<p><b>Spot Drilling</b></p> <p>For plain/straight surfaces, no spot drilling is required. For centering, the center drill diameter should be considerably smaller than the pilot drill diameter.</p>	<p><b>Furação Localizada</b></p> <p>Para superfícies planas a furação localizada não é necessária. O diâmetro da broca de pré-furação deve ser consideravelmente menor do que o diâmetro da broca-piloto.</p>	<p><b>Perforación Localizada</b></p> <p>Para superficies planas, no se requiere la perforación in situ. Para centrar el diámetro de pré-perforación debe ser considerablemente más pequeño que el diámetro de la broca piloto.</p>
		<p><b>Spot drilling and drilling through on inclined surfaces.</b></p> <p>Up to an 8° inclination angle is possible. Drilling through at a maximum of 4° is possible; otherwise, a pre-facing operation is required.</p>	<p><b>Furação localizada e furação através de superfícies inclinadas.</b></p> <p>Até 8° ângulo de inclinação é possível. Furação até a um máximo de 4° é possível, caso contrário, é necessária uma pré-operação.</p>	<p><b>Perforación localizada y perforación sobre superficies inclinadas.</b></p> <p>Hasta un ángulo de inclinación de 8° es posible. A través de la perforación en un máximo de 4° es posible, de otro modo, es necesaria pre-operación.</p>
		<p><b>Multi-Stage Drill Hole</b></p> <p>Vortex series drills are not recommended for boring operations. First, use the Integrex drill to drill a larger diameter hole. Then, use a solid carbide drill for smaller holes. Optimum centering of the solid carbide drill is possible on the drill hole of the pilot drill.</p>	<p><b>Furo Multi-Estágio</b></p> <p>As brocas Vortex não são recomendadas para operações de mandrilagem. Primeiro utilize a Integrex para o furo de diâmetro maior, então use uma broca Metal Duro Integrex para o furo de diâmetro mais reduzido.</p>	<p><b>Multi-etapa taladro</b></p> <p>Las brocas Vortex no son recomendadas para las operaciones de mandrilagen. En primer lugar, utilizar la Integrex para perforar un agujero de diámetro mayor. A continuación, utilice una broca de carburo sólido para los pequeños agujeros. Centrado óptimo del taladro de carburo sólido es posible en el taladro de la broca piloto.</p>
		<p><b>Drilling of stacked plates</b></p> <p>This is not possible with Integrex series drills because a final disc forms when the drill breaks through.</p> <p><b>Caution:</b> During through-hole operations, a slug or disc is produced as the tool breaks through the workpiece. When the drill is stationary and the workpiece is rotating, this slug may be hurled from the chuck by centrifugal force. Provide adequate shielding to protect all bystanders.</p>	<p><b>Furação de chapas empilhadas</b></p> <p>Isso não é possível com a Integrex porque um disco final forma-se quando a broca passa</p> <p><b>Cuidado:</b> Durante operações de trespassar uma placa, uma apara ou disco é produzido quando a broca rompe através da peça. Quando a broca está parada e é a peça rotativa, este disco pode ser arremessado da brecha pela força centrífuga. Proporcionar adequada blindagem para proteger todos os transeuntes.</p>	<p><b>Perforación de placas apiladas</b></p> <p>Esto no es posible con la Integrex debido a un disco que se forma cuando el taladro a través de las placas.</p> <p><b>Precaución:</b> Durante las operaciones a través de agujeros, una babosa o disco se produce como la herramienta provocando saltos de la pieza. Cuando la perforación es estacionaria y la pieza está girando, este disco puede ser lanzado desde el plato por la fuerza centrífuga. Proporcionar la protección adecuada para proteger a todos los transeúntes.</p>

# VORTEX DRILLS - TROUBLESHOOTING

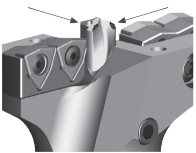
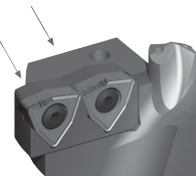
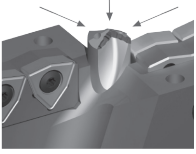
Solução de problemas | Solución de problemas

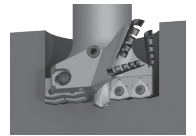
Problem   Problema	Corrective Action	Possível Solução	Solución Posible
<p>PILOT DRILL CRACKING</p> 	<p><b>On Lathes:</b></p> <ul style="list-style-type: none"> <li>• Verify that the tool is centered correctly. Readjust machine, if necessary.</li> <li>• Check clamping accuracy (tool and workpiece).</li> </ul>	<p><b>Em Tornos:</b></p> <ul style="list-style-type: none"> <li>• Verifique se a ferramenta está centrada corretamente. Reajustar a máquina caso necessário.</li> <li>• Verifique a precisão do aperto (ferramenta e peça).</li> </ul>	<p><b>Tornos en:</b></p> <ul style="list-style-type: none"> <li>• Compruebe que la herramienta se centra correctamente. Reajustar la máquina, si es necesario.</li> <li>• Verificar la precisión de sujeción (herramienta y pieza de trabajo) para una posible mejora.</li> </ul>
<p>INSERT CRACKING</p> 	<ul style="list-style-type: none"> <li>• Use tougher carbide grade.</li> <li>• Check clamping accuracy (tool and workpiece) for possible run out.</li> </ul>	<ul style="list-style-type: none"> <li>• Use classes de graus mais duras.</li> <li>• Verifique a precisão do aperto (ferramenta e peça).</li> </ul>	<ul style="list-style-type: none"> <li>• Uso más duras de carburo de grado.</li> <li>• Verificar la precisión de sujeción (herramienta y pieza de trabajo) para su posible run out.</li> </ul>
<p>EXCESSIVE INSERT WEAR</p> 	<ul style="list-style-type: none"> <li>• Use coated pilot drill.</li> <li>• Increase coolant pressure and volume.</li> <li>• Reduce speed by 20%</li> <li>• Use wear &amp; resistant carbide grade.</li> </ul>	<ul style="list-style-type: none"> <li>• Utilizar uma broca piloto revestida.</li> <li>• Aumentar o volume e a pressão do líquido de refrigeração.</li> <li>• Reduzir a velocidade de corte em 20%.</li> <li>• Utilizar classes de graus mais resistentes ao desgaste.</li> </ul>	<ul style="list-style-type: none"> <li>• Utilice broca piloto revestida.</li> <li>• Aumentar la presión del refrigerante y el volumen.</li> <li>• Reduzca la velocidad en un 20%</li> <li>• Utilice el desgaste y resistentes de carburo de grado.</li> </ul>
<p>CHIP BREAKING NOT OPTIMAL</p> 	<ul style="list-style-type: none"> <li>• Optimize chip control for given application by using different chipbreaker geometry.</li> <li>• Increase cutting speed by 20%; reduce feed by 20%.</li> </ul>	<ul style="list-style-type: none"> <li>• Optimizar o controlo da aparã numa determinada operação outra geometria de quebra aparã.</li> <li>• Aumentar a velocidade de corte em 20% e reduzir o avanço em 20%.</li> </ul>	<ul style="list-style-type: none"> <li>• Optimizar el control de viruta numa dada aplicación mediante utilización de otra geometría quebra viruta</li> <li>• Aumentar la velocidad de corte en un 20%, reducir la alimentación en un 20%.</li> </ul>
<p>CHIP EVACUATION NOT OPTIMAL, POOR DRILL HOLE QUALITY</p> 	<ul style="list-style-type: none"> <li>• Increase coolant pressure and volume.</li> <li>• Increase cutting speed by 20%.</li> </ul>	<ul style="list-style-type: none"> <li>• Aumentar o volume e a pressão do líquido de refrigeração.</li> <li>• Aumentar a velocidade de corte em 20%.</li> </ul>	<ul style="list-style-type: none"> <li>• Aumentar la presión del refrigerante y el volumen.</li> <li>• Aumentar la velocidad de corte en un 20%.</li> </ul>

## SAFETY

### Caution:

• During trough-hole operations, a slug or disc is produced as the tool breaks through the workpiece. When the drill is stationary and the workpiece is rotating, this slug may be hurled from the chuck by centrifugal force. Provide adequate shielding to protect all bystanders.

• When drilling through, a small shoulder will be produced on breakthrough as the pilot drill is no longer cutting.



## VORTEX DRILL MDO 10D

### HEADQUARTERS

PALBIT, S.A.

P.O.Box 4 - Palhal

3854-908 - Branca ALB - Portugal

T (+351) 234 540 300 | F (+351) 234 540 301

palbit@palbit.pt | [www.palbit.pt](http://www.palbit.pt)

### Branch office:

PALBIT México

Emerson 150. Int.803-804. Colonia Chapultepec

Morales Delagación Miguel Hidalgo

C.P. 11570 México DF

T (+52) 5555 454 543 | F (+52) 5552 509 190

info@palbit.com.mx | [www.palbit.com.mx](http://www.palbit.com.mx)

### Branch office:

PALBIT Brasil

Av. João XXIII, nº20 Salas 41 e 65

Vila Gilda, Sto André, SP

CEP: 09190-500 – São Paulo – Brasil

palbit@palbit.com.br | [www.palbit.com.br](http://www.palbit.com.br)



SINCE 1916